

A decorative background featuring a repeating diamond or lattice pattern in the corners. The pattern consists of thick black lines forming a grid of diamonds, with a smaller, lighter gray diamond pattern nested within each larger diamond. The central area of the page is a solid dark gray.

Outdoor Porcelain Tiles
2023-2024

About US



Group is one of the leading manufacturer & exporter of technically-advanced, Vitrified Tiles & Sanitary Ware, providing an extensive range of tile decor options for both residential and commercial interiors. We believe in values of - "innovation, Quality Products and Customer Satisfaction". Product Range : Vitrified Tiles & Sanitary Ware.

These offered range of tiles find applications in Residential & Commercial complexes, IT Parks, Hotels & Restaurants, Airports, Hospitals as well as other housing constructions and restoration of existing structures.

Backed with advanced & sophisticated state-of-the-art infrastructure facility, we are well-equipped with latest designing & manufacturing amenities. This also facilitates us in persistently improving every aspect of our operations. Further, we lay prime emphasis on the human factors occupied in our business.

let me
introduce

you to the strong and
gentle soul of stone

600x1200mm

600x900mm

Thickness
16mm | 20mm

600x600mm

Size (mm)	600x1200 600x900 600x600
Thickness (mm)	16mm 20mm
Surface	MATT- R09 R11
Surface Punch	Plain Stone Slate
Color Body	Ivory Grey Black



VIENNA SILK



VENICE BLUE



LAGOS NATURAL



CHEPO BEIGE



Boston Choko

1

Bring Fabulous
Design

2

Classic design

3

Shades of Petals
Look

4

A Perfect Ideal
Choice

OUTDOOR PORCELAIN TILES

A versatile and high-performance porcelain stoneware, incorporating all the aesthetic qualities of natural stone, for spaces in which people are the focal point, surrounded by beautiful and eternal surfaces that combine wellbeing, beauty and practicality

The requirements of modern architecture are combined with the fascination with natural stone. Inspiration has been taken from Irish Stone, proposing new systems for a covering of great aesthetic value, destined to be a key feature.

TILE LAYING POSSIBILITIES

16 | 20mm THICKNESS

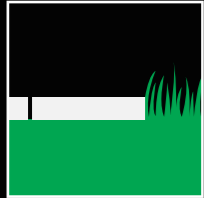

LAYING ON SCREED
WITH ADHESIVES

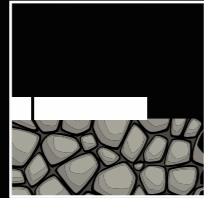

LAYING ON A
RAISED FLOOR

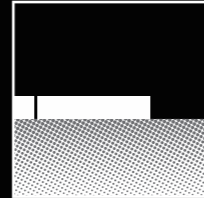

LAYING ON
GRAVEL

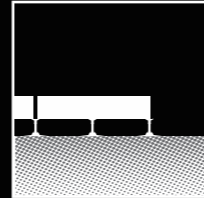

DRY LAYING ON
THE GRASS



A reflection on the primitive and minimalist form of stone and on the different finishes that originate from the different ways of working this material: this is what inspired the Stonetalk collection.

The various that make up the collection capture all the splendor of real marble, highlighting one of the wonders offered by nature and provoking at the very first sight the same strong emotional impact experienced.



The dark stone stands out due to its decisive but refined mood and can also transmit these features to large architectural spaces.



ROBUST THICKNESS MIGHTY DURABILITY

20MM
THICKNESS



The substantial thickness of 20mm of the collection lends the surfaces exceptional durability and resilience. The thickness offers surfaces durability to endure heavy traffic, weight, and rugged use and makes the surfaces practically ideal for all kinds of usages. The thickness paired with R11 anti-skid surfaces makes the surfaces of the collection extremely safe for use outdoors.

BENIFITS OF 20MM OUTDOOR TILES

Stress-Resistant			High Tensile Strength
Antislip (R11)			Weather Resistant
Easy To Clean Due To The Lack Of Adhesives And Filler			Easy To Install Even Without Adhesives Or Filler
Frost And Fire-resistant			Removable And Reusable
Good Drainage, Facilitates The Flow Of Water And Rainfall, Eliminating Harmful Stagnation			Ideal For Paving Outdoor Installations, Including Raised Paving.
Easily Inspected And Functional, Allows Installation And Maintenance Of Cabling And Pipework.			Highly Resistant To Changes In Temperature

The robustly crafted collection comes with a plethora of features and benefits and aids in an effortless and risk-free lifestyle with attributes like r11 anti-slip surfaces, resistance to heat, frost, fire, weather, stains, and more, and also very easy to maintain. On top of features, the surfaces are easy to install, removable, and reusable.

OUTDOOR PORCELAIN TILES

APPLICATIONS AND SOLUTIONS

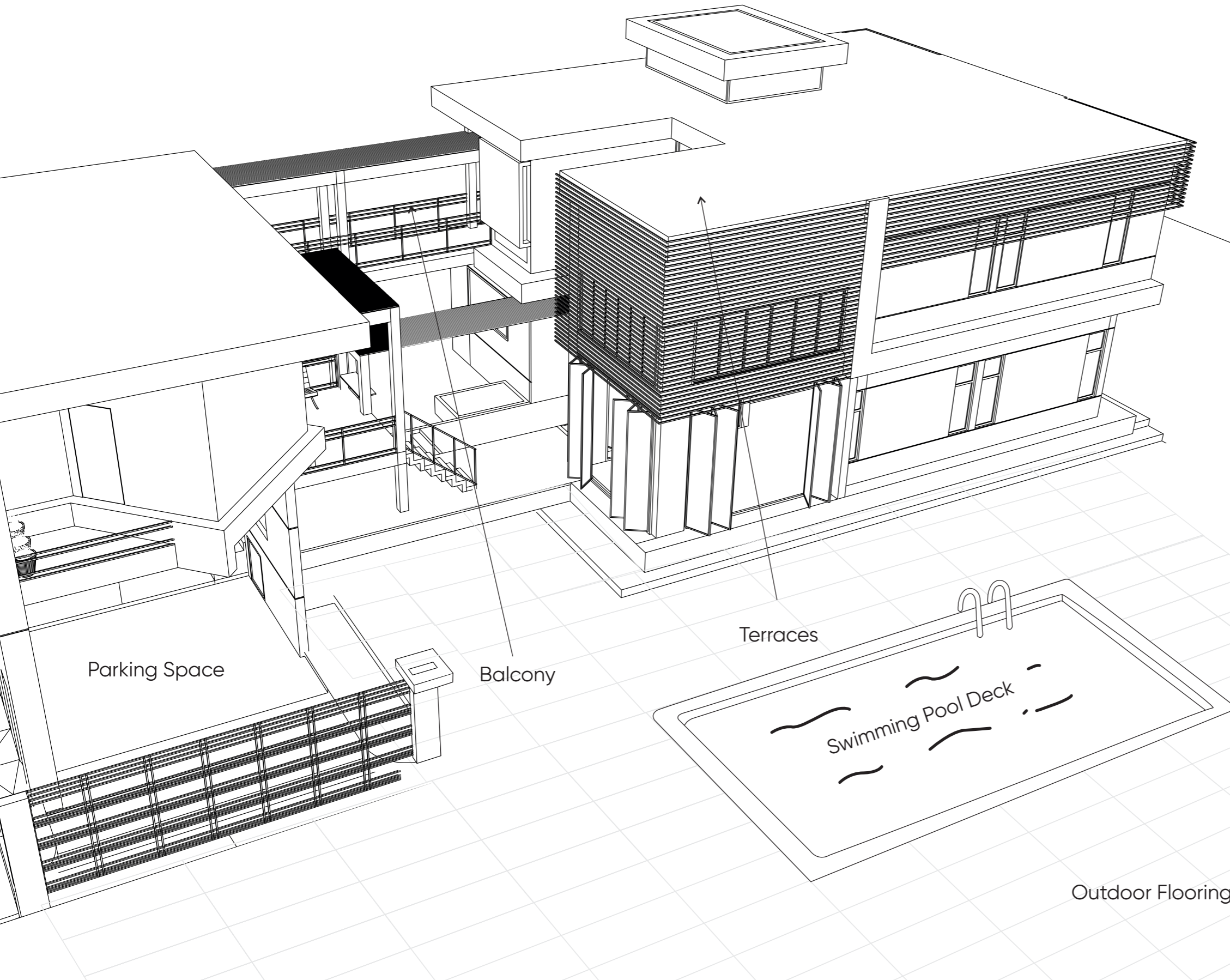

Terraces, pathways and covered pools clad with 20mm outdoor porcelain effortlessly merge with the surrounding spaces and nature. Internal flooring that seamlessly communicates and runs into external surfaces. With 20mm outdoor porcelain, urban areas like public parks, gardens and swimming pools unexpectedly become delightful scenic locations.

The products featured in this catalogue are primarily suggested for external spaces that require floorings with anti-skid properties.

Parking Lot

Outdoor Flooring

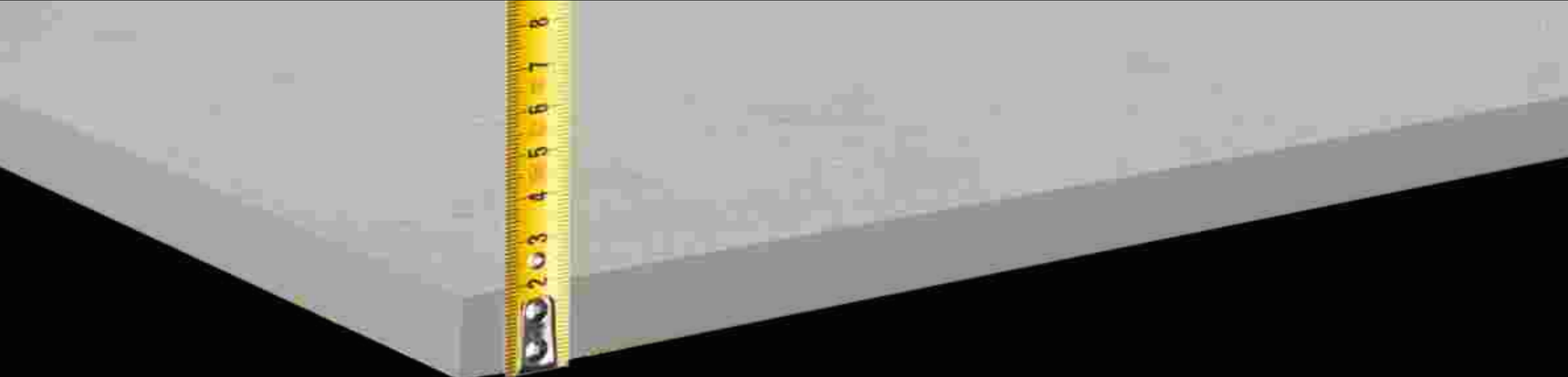

Application Areas

Our 20 mm thick Outdoor Porcelain vitrified tile by Our brings together aesthetically appealing quality and the best technical performance and could be used over almost all external areas and usages without the risk of breakage. They are resistant to frost and also to sudden temperature changes besides being anti-slip, easy to clean and are designed to retain their texture and colour over their lifetime.



Public Parks,
Gardens



Terraces and
Balconies

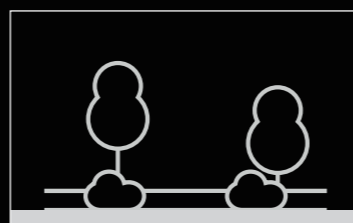

Driveways and
Pathways

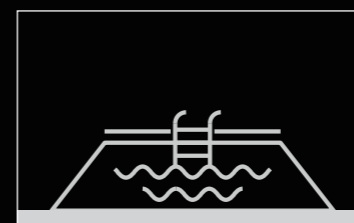

Swimming Pools and
Surrounding Areas



Out door patio and
verandah

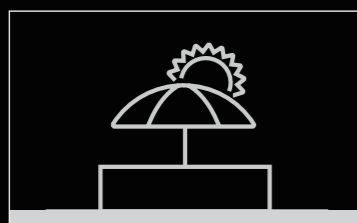

Beach
Resorts

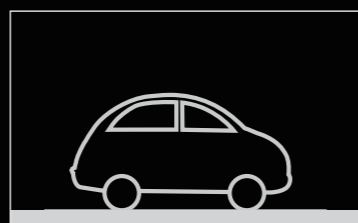

Parking Lots and
Vehical Passage

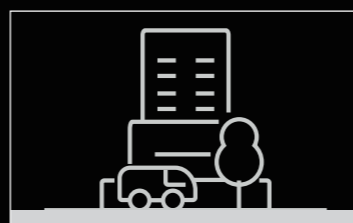

Street
Furniture



High-traffic
Industrial Areas



TERRACES

Laying Patterns

**MAKE NATURAL LOOKING PATTERNS
LIKE INTERLOCKING, RANDOM,
REPETITIVE, SQUARES WITH
OUR OUTDOOR PORCELAIN**

Tiles Combination & Cutting Tiles

600x1200mm | 600x900mm | 600x600mm | 300x600mm | 300x300mm



Please note that your stockist may offer the tiles in different pack sizes. All dimensions are standard and all products are designed to be laid with appropriate joints. Please refer to our step-by-step laying guide for additional information on this topic. Also, when using multiple tile packs, always mix the tiles before laying to achieve an overall blended appearance.

Tiles Combination

600x1200mm

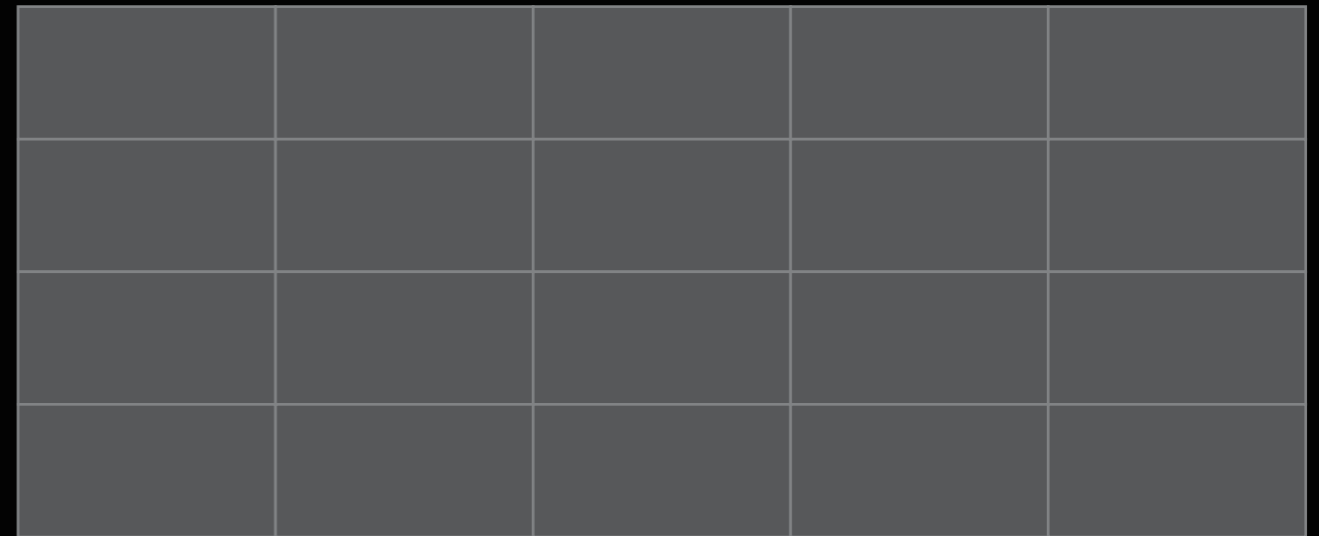

Tiles Combination

600x900mm



Tiles Combination & Cutting Tiles

600x600mm

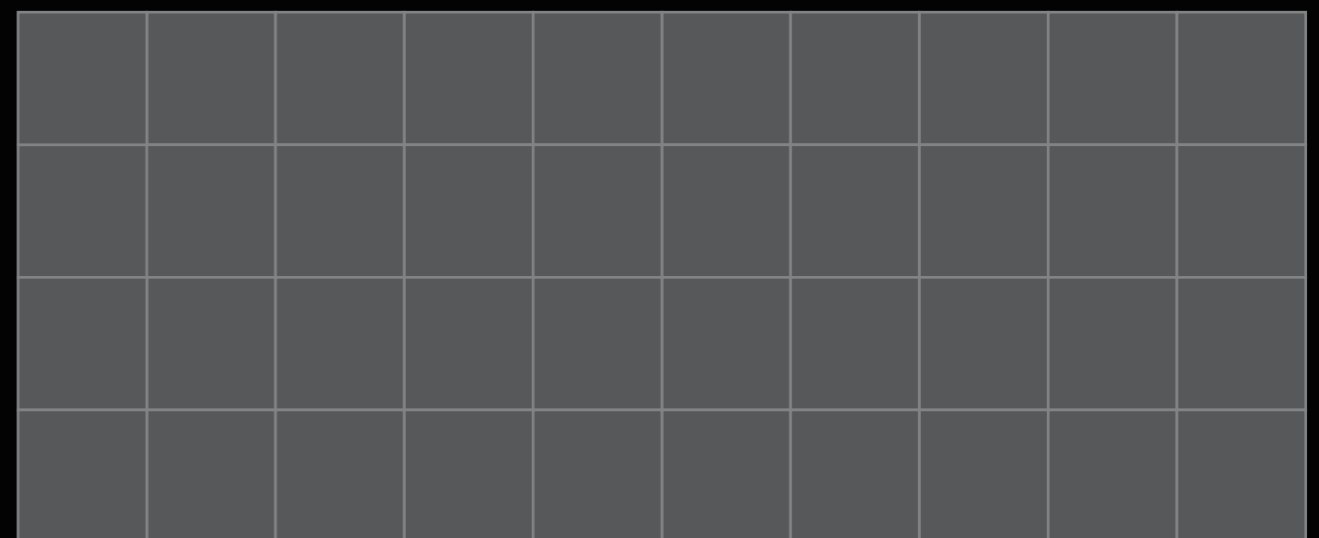

INDEX

■ AUSTIN BIANCO.....10	■ KANDY GREY.....42	■ POZZOLANA GREY.....74	■ VENICE BIANCO.....106
■ AUSTIN GREY.....12	■ LAGOS BEIGE.....44	■ POZZOLANA MARRON.....76	■ VENICE BLUE.....108
■ BOSTON CHOKO.....14	■ LAGOS BIANCO.....46	■ POZZOLANA SMOKE.....78	■ VENICE GREEN.....110
■ CAMLIN BIANCO.....16	■ LAGOS NATURAL.....48	■ ROCK BEIGE.....80	■ VENICE GREY.....112
■ CAMLIN RUST.....18	■ MEDINA BLANCO.....50	■ ROCK BIANCO.....82	■ VIENNA SILK.....114
■ CHEPO BEIGE.....20	■ MEDINA BURLY.....52	■ ROCK BROWN.....84	■ VOLGA BIANCO.....116
■ CHEPO BIANCO.....22	■ MEDINA COTTO.....54	■ ROCK CEMENTO.....86	■ VOLGA SILK.....118
■ CHEPO GREY.....24	■ MEDINA GRIS.....56	■ ROCK GRIS.....88	■ HAMMER STONE BEIGE.....120
■ CHEPO MILK.....26	■ MEDINA MARRON.....58	■ ROCK NATURAL.....90	■ LAVA STONE.....122
■ CONCRETE BLANCO.....28	■ MEDINA NEGRO.....60	■ ROCK TAUPE.....92	■ QUARTZ GREY.....124
■ CONCRETE COTTO.....30	■ MILANO BEIGE.....62	■ ROME BEIGE.....94	■ QUARTZ WHITE.....126
■ CONCRETE MARRON.....32	■ PERTH BEIGE.....64	■ ROME BIANCO.....96	■ SHERPA BEIGE.....128
■ CONCRETE NATURAL.....34	■ PERTH BIANCO66	■ ROME DARK GREY.....98	■ SHERPA GREY.....130
■ KANDY BEIGE.....36	■ PERTH CHOKO.....68	■ ROME LIGHT GREY.....100	
■ KANDY BIANCO.....38	■ PORTO GREY.....70	■ SWISS DARK.....102	
■ KANDY GREEN.....40	■ POZZOLANA BURLY.....72	■ SWISS LIGHT.....104	

AUSTIN BIANCO

SURFACE

MATT- R09 | R11

THICKNESS

16mm | 20mm

SIZE

600x1200mm
600x900mm
600x600mm

Plain Punch
Slate Punch
Stone Punch

Random- 3



Experience

The Luxury Perfection





AUSTIN BIANCO

AUSTIN GREY

SURFACE

MATT- R09 | R11

THICKNESS

16mm | 20mm

SIZE

600x1200mm
600x900mm
600x600mm

Plain Punch
Slate Punch
Stone Punch

Random- 3



Enjoy
The Beauty
Of Symmetry





AUSTIN GREY

BOSTON CHOKO

SURFACE

MATT- R09 | R11

THICKNESS

16mm | 20mm

SIZE

600x1200mm
600x900mm
600x600mm

Plain Punch
Slate Punch
Stone Punch

Random- 2



Quirky Charm To Your Spaces





BOSTON CHOKO

CAMLIN BIANCO

SURFACE

MATT- R09 | R11

THICKNESS

16mm | 20mm

SIZE

600x1200mm
600x900mm
600x600mm

Plain Punch
Slate Punch
Stone Punch

Random- 3



Adds

Character To Your Spaces



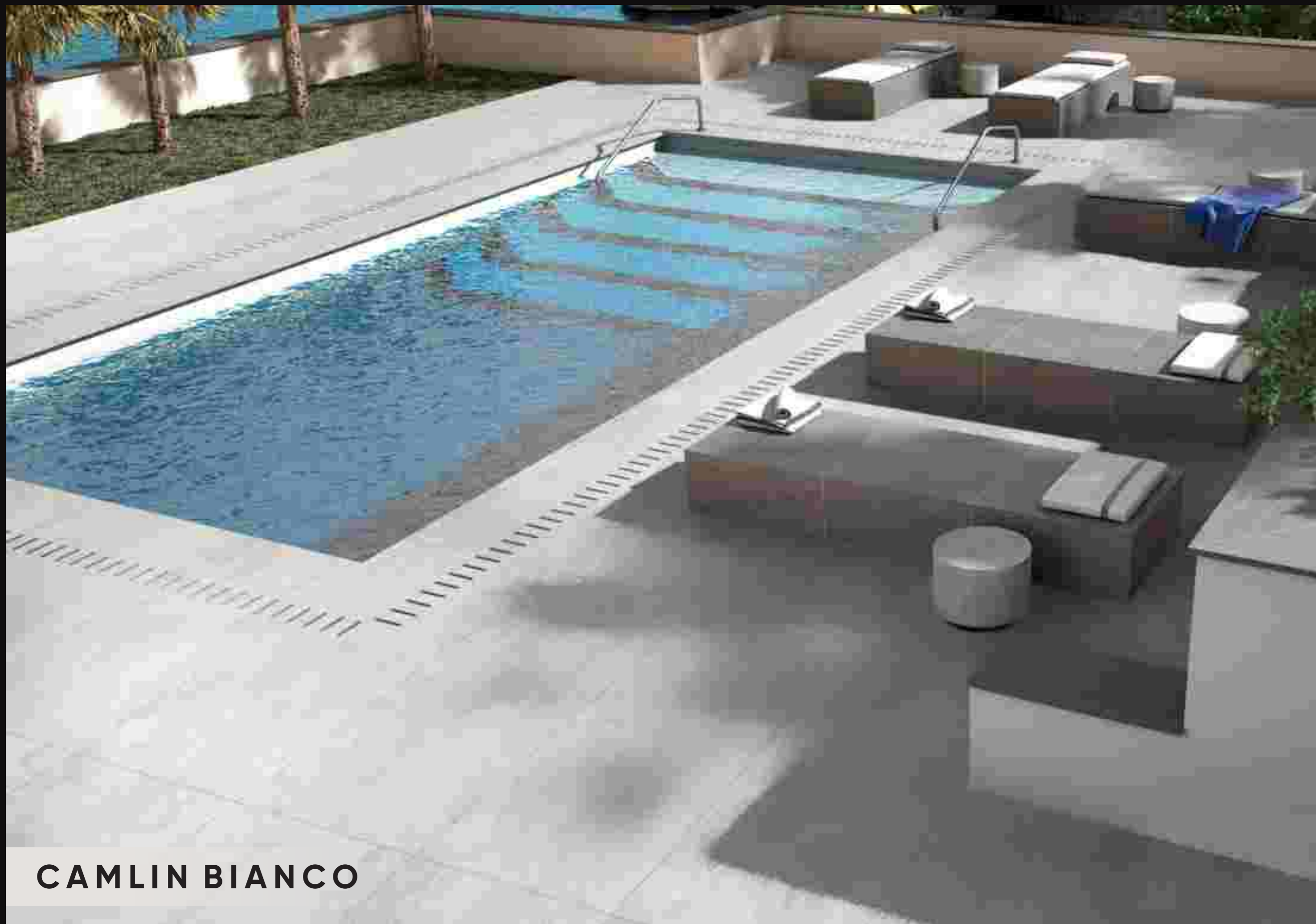

CAMLIN BIANCO

CAMLIN RUST

SURFACE

MATT- R09 | R11

THICKNESS

16mm | 20mm

SIZE

600x1200mm
600x900mm
600x600mm

Plain Punch
Slate Punch
Stone Punch

Random- 3



Mediterranean Calm To Your Spaces



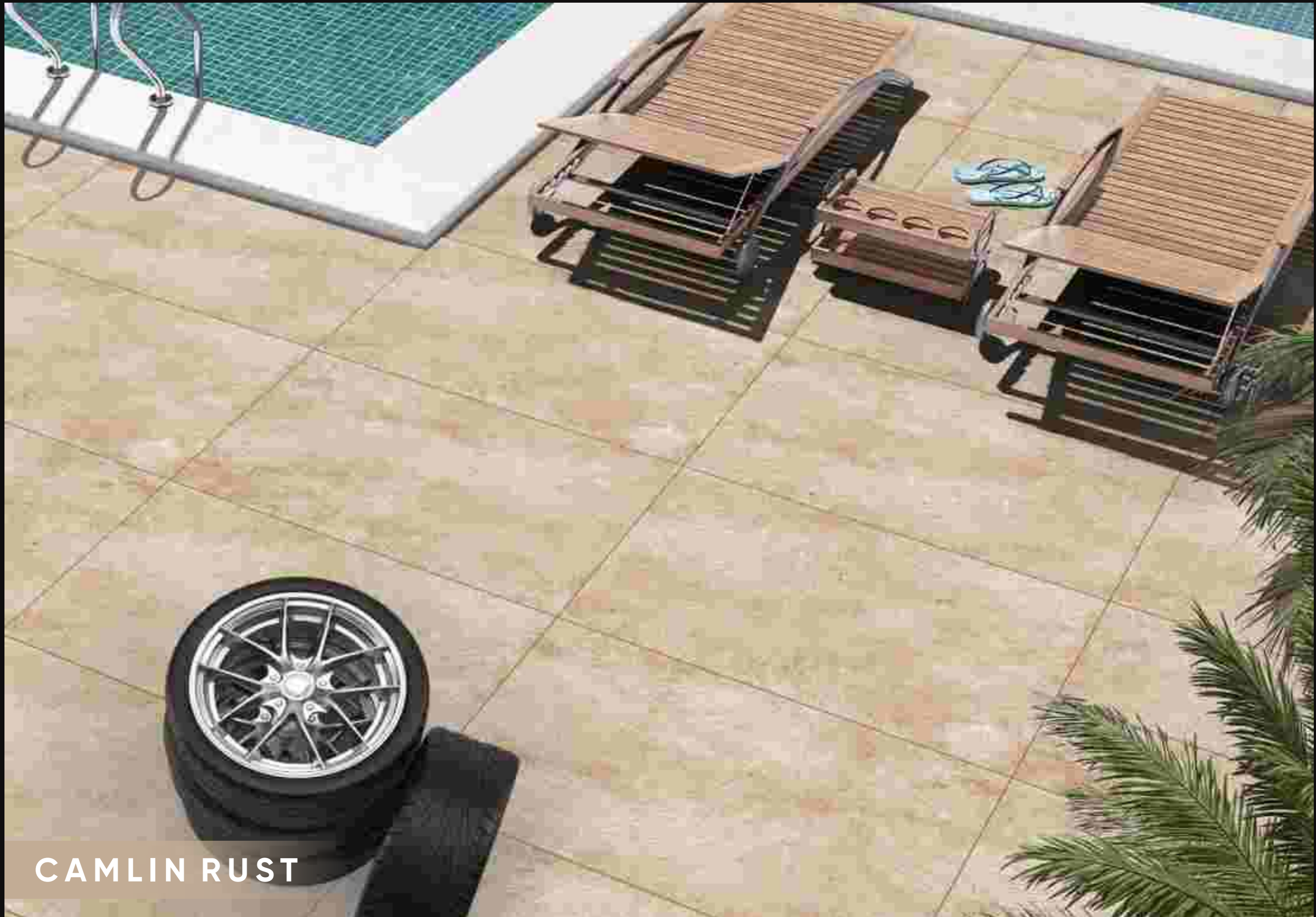

CAMLIN RUST

CHEPO BEIGE

SURFACE

MATT- R09 | R11

THICKNESS

16mm | 20mm

SIZE

600x1200mm

600x900mm

600x600mm

Random- 4

Plain Punch
Slate Punch
Stone Punch



Elegance
To Your
Ambiance





CHEPO BEIGE

CHEPO BIANCO

SURFACE

MATT- R09 | R11

THICKNESS

16mm | 20mm

SIZE

600x1200mm
600x900mm
600x600mm

Random- 4

Plain Punch
Slate Punch
Stone Punch

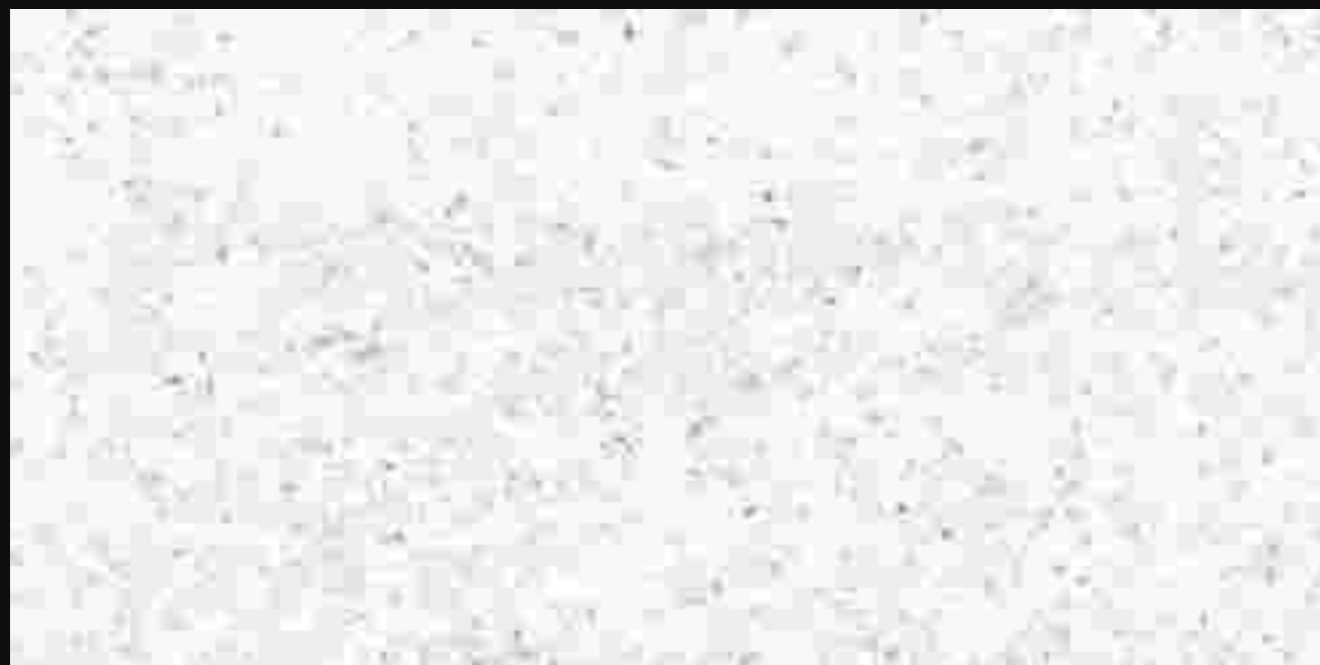
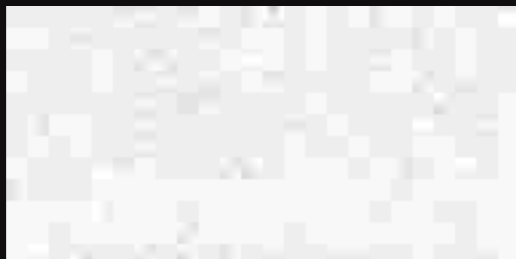
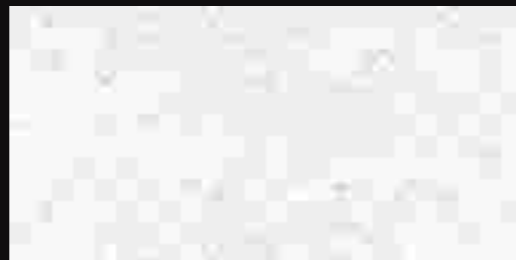

Achieve
Brilliant And
Luxurious Spaces

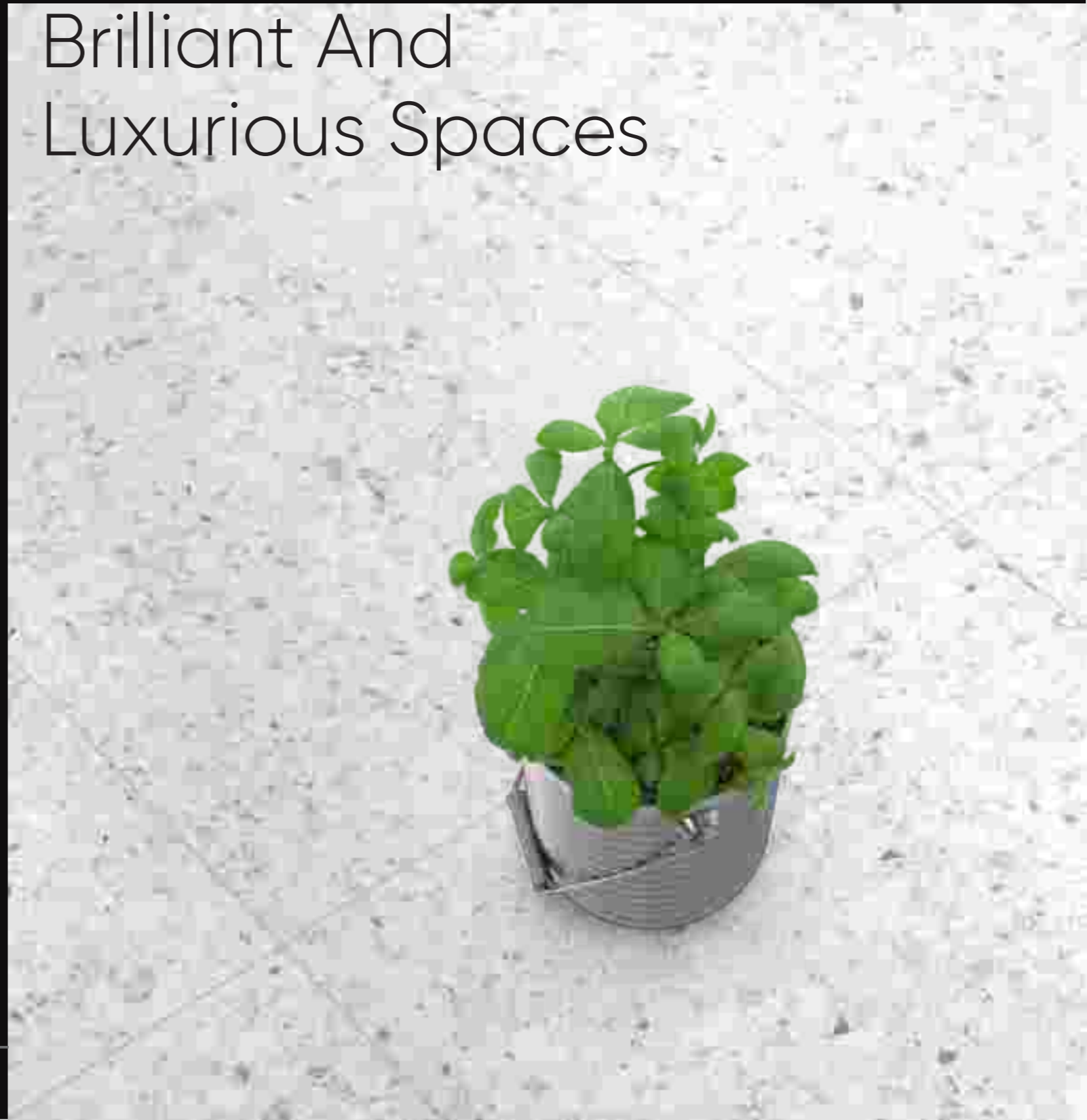



CHEPO BIANCO

CHEPO GREY

SURFACE

MATT- R09 | R11

THICKNESS

16mm | 20mm

SIZE

600x1200mm

600x900mm

600x600mm

Random- 4

Plain Punch
Slate Punch
Stone Punch



Enhance

The Surreal Ambiance Of Your Spaces

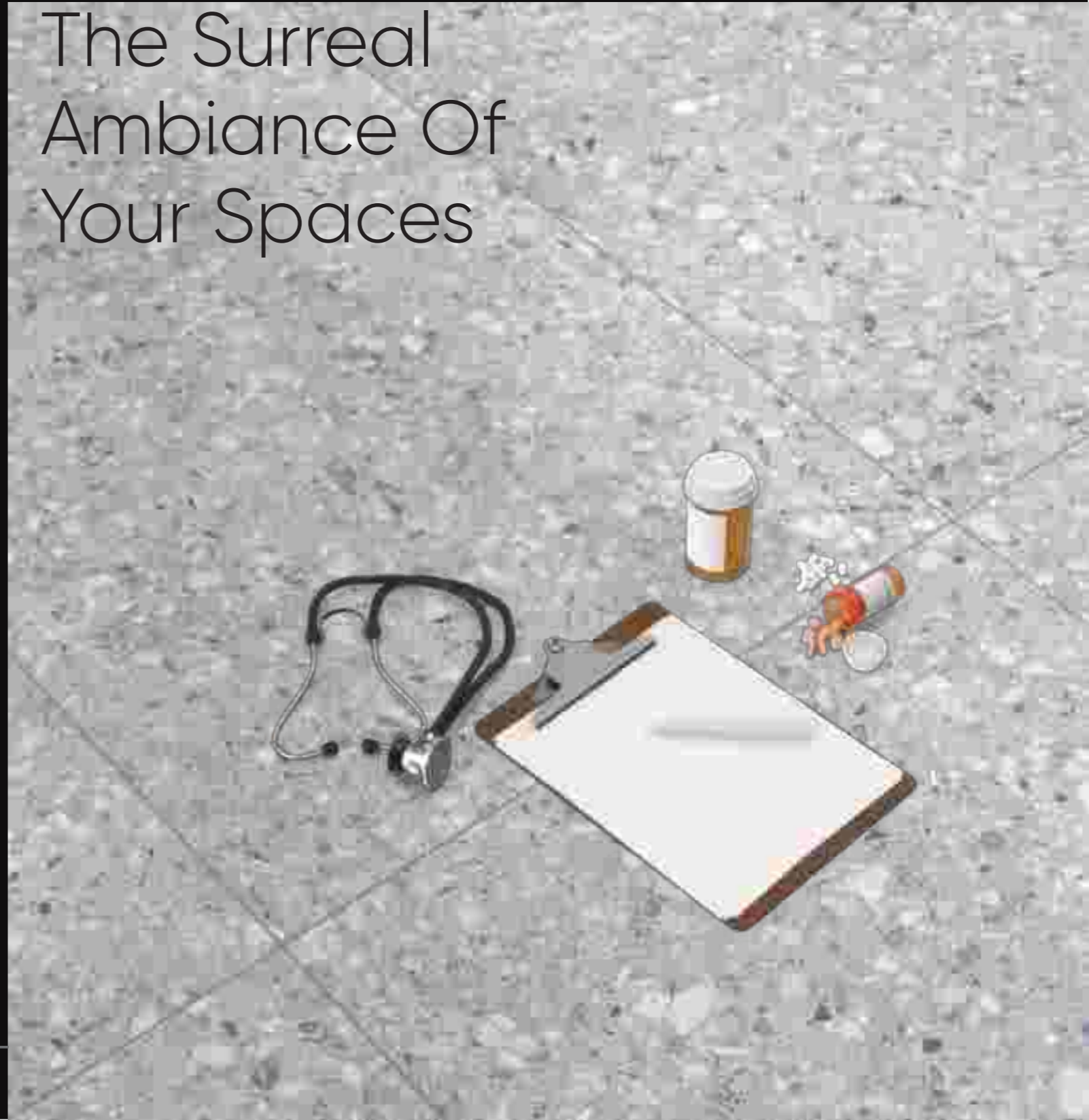



CHEPO GREY

CHEPO MILK

SURFACE

MATT- R09 | R11

THICKNESS

16mm | 20mm

SIZE

600x1200mm

600x900mm

600x600mm

Random- 4

Plain Punch
Slate Punch
Stone Punch



Embellish

The Botanic
Architectural
Richness





CHEPO MILK

CONCRETE BLANCO

SURFACE

MATT- R09 | R11

THICKNESS

16mm | 20mm

SIZE

600x1200mm

600x900mm

600x600mm

Random- 4

Plain Punch
Slate Punch
Stone Punch



Transform Your Spaces Decorative And Ornate

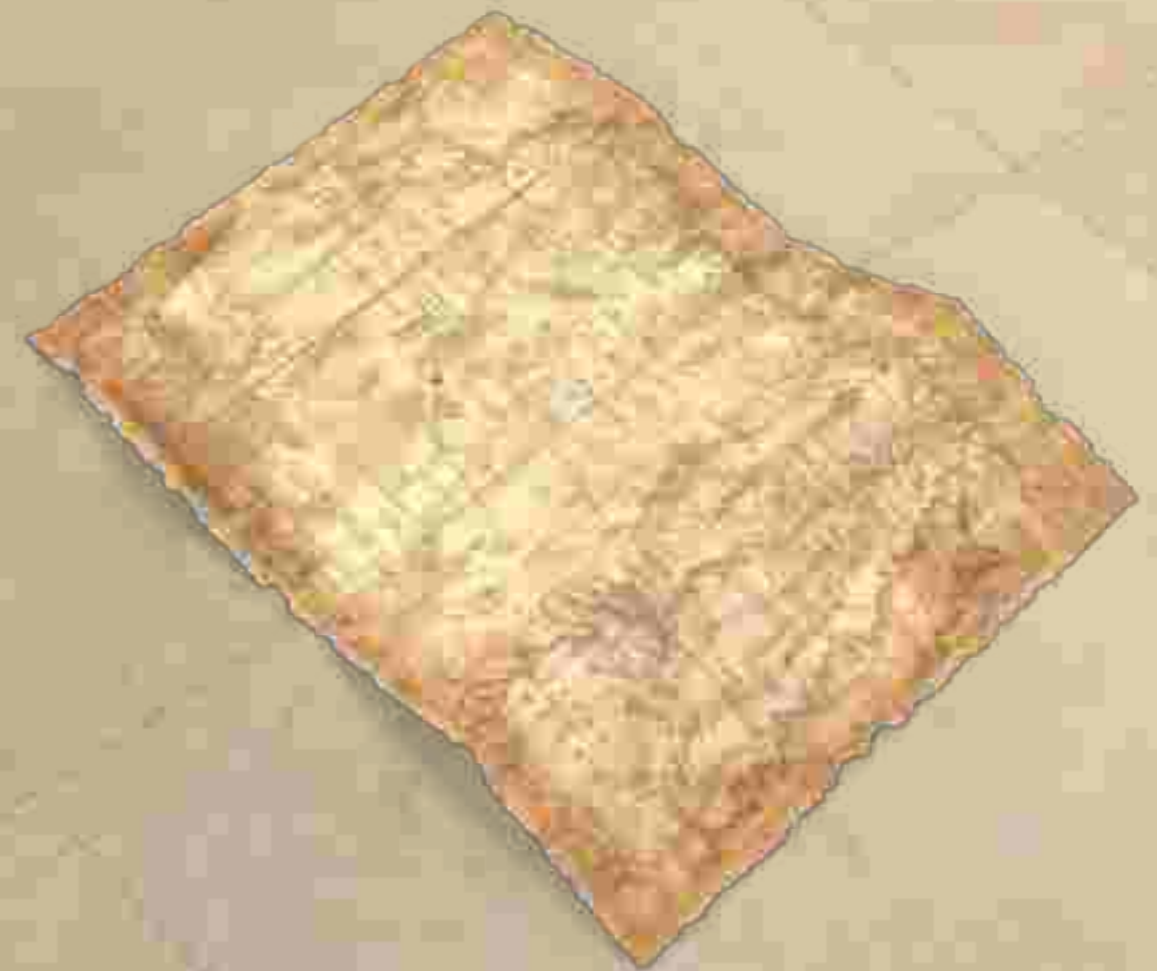



CONCRETE BLANCO

CONCRETE COTTO

SURFACE

MATT- R09 | R11

THICKNESS

16mm | 20mm

SIZE

600x1200mm
600x900mm
600x600mm

Random- 4

Plain Punch
Slate Punch
Stone Punch



Design Your Spaces Creative And Mesmeric

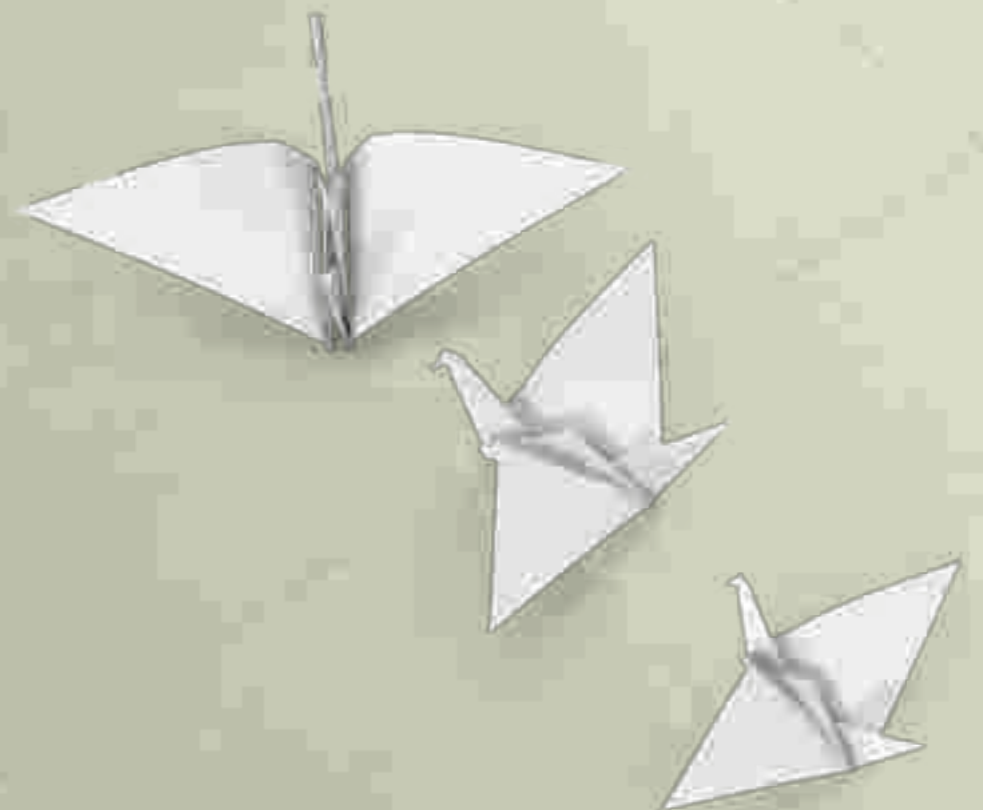



CONCRETE COTTO

CONCRETE MARRON

SURFACE

MATT- R09 | R11

THICKNESS

16mm | 20mm

SIZE

600x1200mm
600x900mm
600x600mm

Random- 4

Plain Punch
Slate Punch
Stone Punch

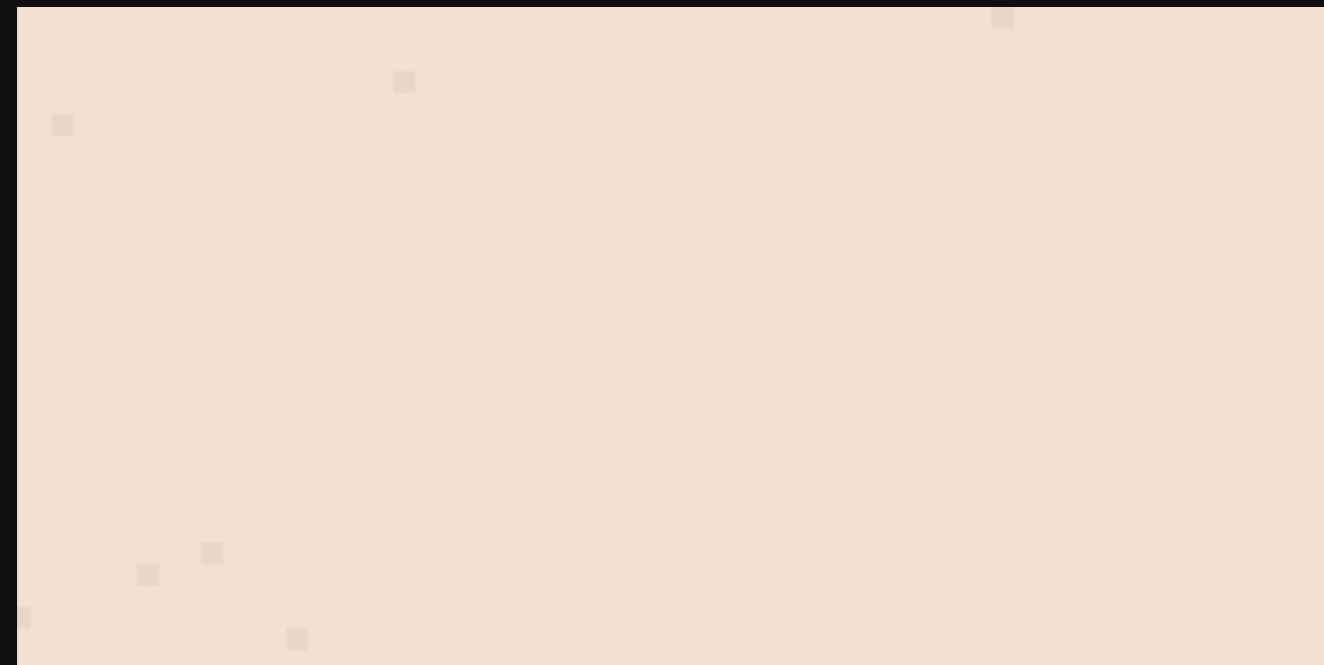

Shades

Give A Sense
Of Unity





CONCRETE MARRON

CONCRETE NATURAL

SURFACE

MATT- R09 | R11

THICKNESS

16mm | 20mm

SIZE

600x1200mm

600x900mm

600x600mm

Random- 4

Plain Punch
Slate Punch
Stone Punch

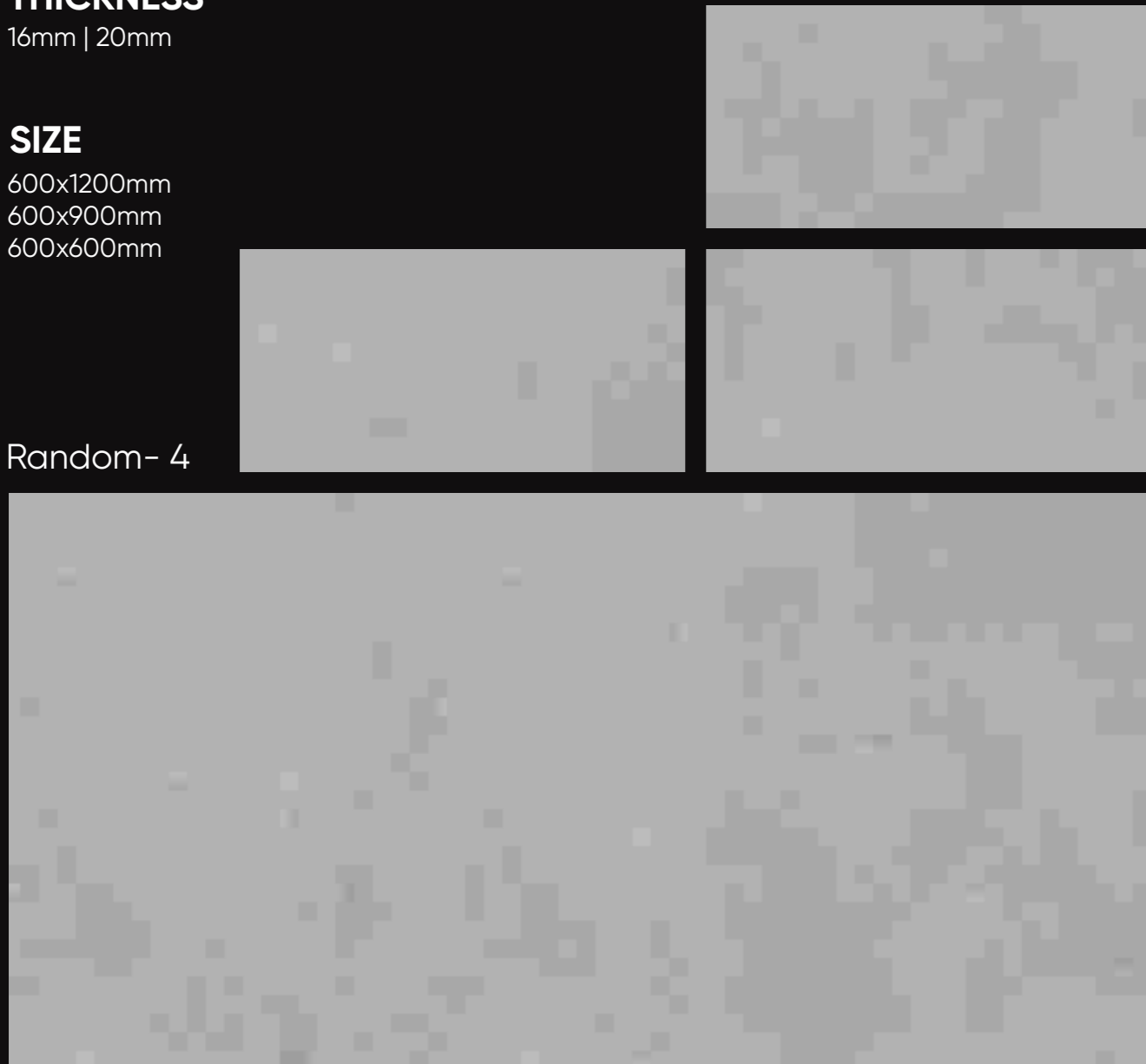

Carve

Your Dream
Into Reality





CONCRETE NATURAL

KANDY BEIGE

SURFACE

MATT- R09 | R11

THICKNESS

16mm | 20mm

SIZE

600x1200mm
600x900mm
600x600mm

Plain Punch
Slate Punch
Stone Punch

Random- 3



Accentuate

The Accents In Your Living Spaces





KANDY BEIGE

KANDY BIANCO

SURFACE

MATT- R09 | R11

THICKNESS

16mm | 20mm

SIZE

600x1200mm
600x900mm
600x600mm

Plain Punch
Slate Punch
Stone Punch

Random- 3



Transform
Your Regular
Into Something
Exceptional





KANDY BIANCO

KANDY GREEN

SURFACE

MATT- R09 | R11

THICKNESS

16mm | 20mm

SIZE

600x1200mm
600x900mm
600x600mm

Plain Punch
Slate Punch
Stone Punch

Random- 3



Extraordinary
design for
your spaces





KANDY GREEN

KANDY GREY

SURFACE

MATT- R09 | R11

THICKNESS

16mm | 20mm

SIZE

600x1200mm
600x900mm
600x600mm

Plain Punch
Slate Punch
Stone Punch

Random- 3

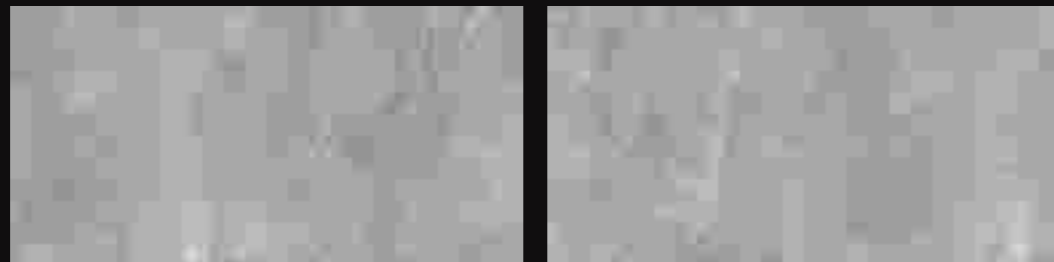

Achieve
Brilliant And
Luxurious Spaces





KANDY GREY

LAGOS BEIGE

SURFACE

MATT- R09 | R11

THICKNESS

16mm | 20mm

SIZE

600x1200mm
600x900mm
600x600mm

Plain Punch
Slate Punch
Stone Punch

Random- 3

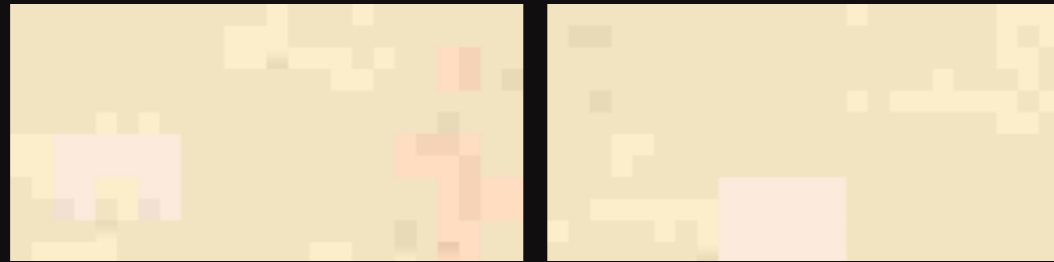

Make
Your Place,
As Your Dream





LAGOS BEIGE

LAGOS BIANCO

SURFACE

MATT- R09 | R11

THICKNESS

16mm | 20mm

SIZE

600x1200mm
600x900mm
600x600mm

Plain Punch
Slate Punch
Stone Punch

Random- 3



Elegance
To Enhance
Your Ambience





LAGOS BIANCO

LAGOS NATURAL

SURFACE

MATT- R09 | R11

THICKNESS

16mm | 20mm

SIZE

600x1200mm
600x900mm
600x600mm

Plain Punch
Slate Punch
Stone Punch

Random- 3



Enhance

The Environment Of Your Space





LAGOS NATURAL

MEDINA BLANCO

SURFACE

MATT- R09 | R11

THICKNESS

16mm | 20mm

SIZE

600x1200mm
600x900mm
600x600mm

Plain Punch
Slate Punch
Stone Punch

Random- 3



Bring In
The Trendy
Designs You
Need





MEDINA BLANCO

MEDINA BURLY

SURFACE

MATT- R09 | R11

THICKNESS

16mm | 20mm

SIZE

600x1200mm
600x900mm
600x600mm

Plain Punch
Slate Punch
Stone Punch

Random- 3



Give
Your Space
A Stunning Look





MEDINA BURLY

MEDINA COTTO

SURFACE

MATT- R09 | R11

THICKNESS

16mm | 20mm

SIZE

600x1200mm
600x900mm
600x600mm

Plain Punch
Slate Punch
Stone Punch

Random- 3



Aesthetic Charm To The Space





MEDINA COTTO

MEDINA GRIS

SURFACE

MATT- R09 | R11

THICKNESS

16mm | 20mm

SIZE

600x1200mm
600x900mm
600x600mm

Plain Punch
Slate Punch
Stone Punch

Random- 3



Creates

Balanced And Minimal Spaces





MEDINA GRIS

MEDINA MARRON

SURFACE

MATT- R09 | R11

THICKNESS

16mm | 20mm

SIZE

600x1200mm
600x900mm
600x600mm

Plain Punch
Slate Punch
Stone Punch

Random- 3



Create A
Balanced And
Subtle Atmosphere





MEDINA MARRON

MEDINA NEGRO

SURFACE

MATT- R09 | R11

THICKNESS

16mm | 20mm

SIZE

600x1200mm
600x900mm
600x600mm

Plain Punch
Slate Punch
Stone Punch

Random- 3



Unmatched
Brilliance
Of Style

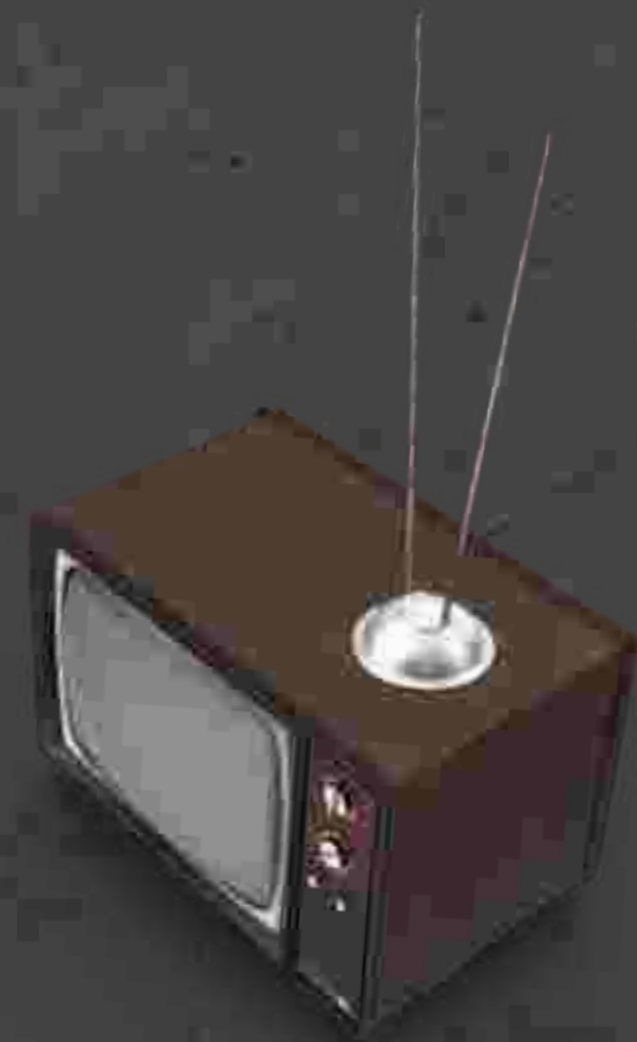

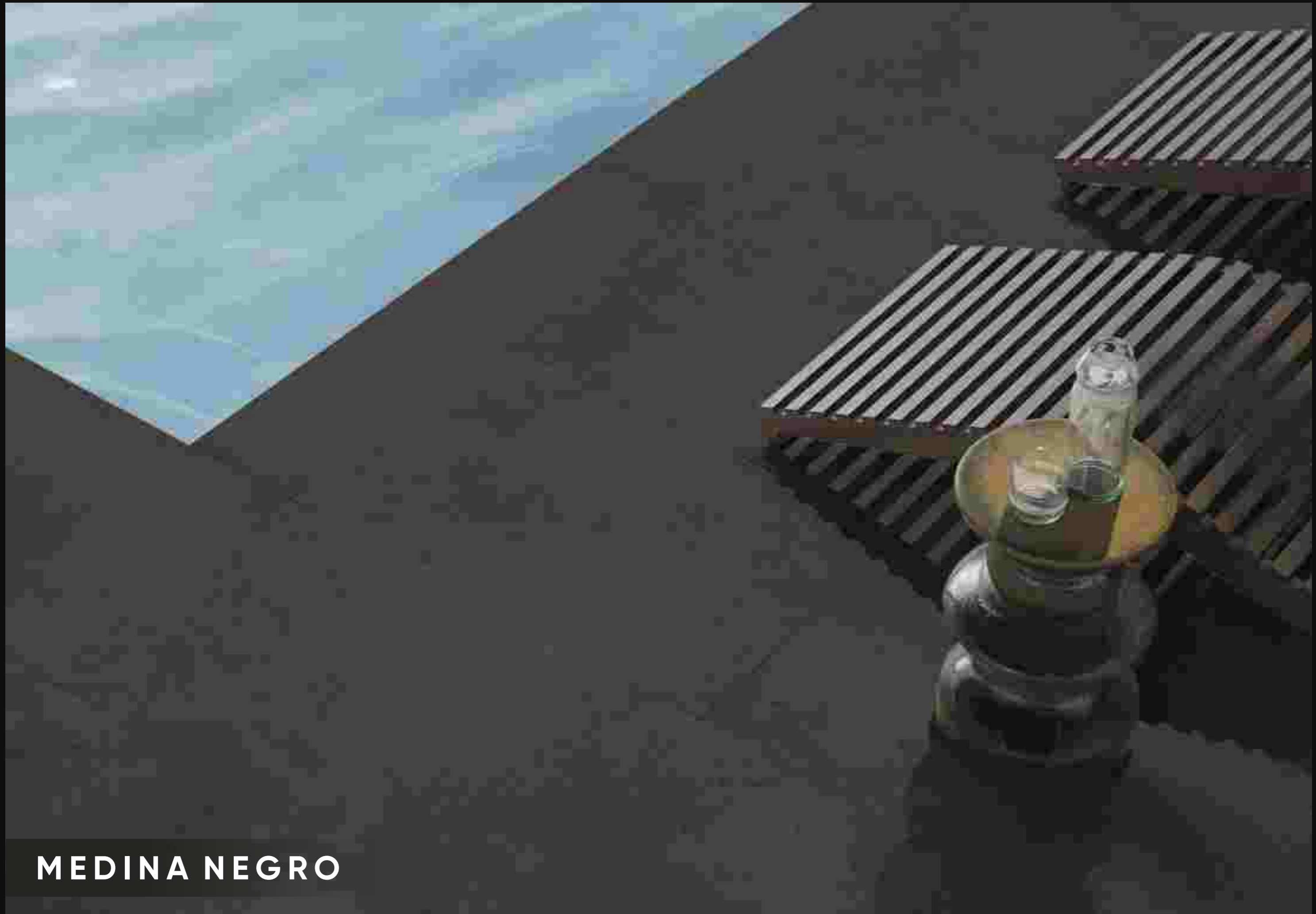

MEDINA NEGRO

MILANO BEIGE

SURFACE

MATT- R09 | R11

THICKNESS

16mm | 20mm

SIZE

600x1200mm
600x900mm
600x600mm

Random- 5

Plain Punch
Slate Punch
Stone Punch



The Impact Of Graceful Ambiance

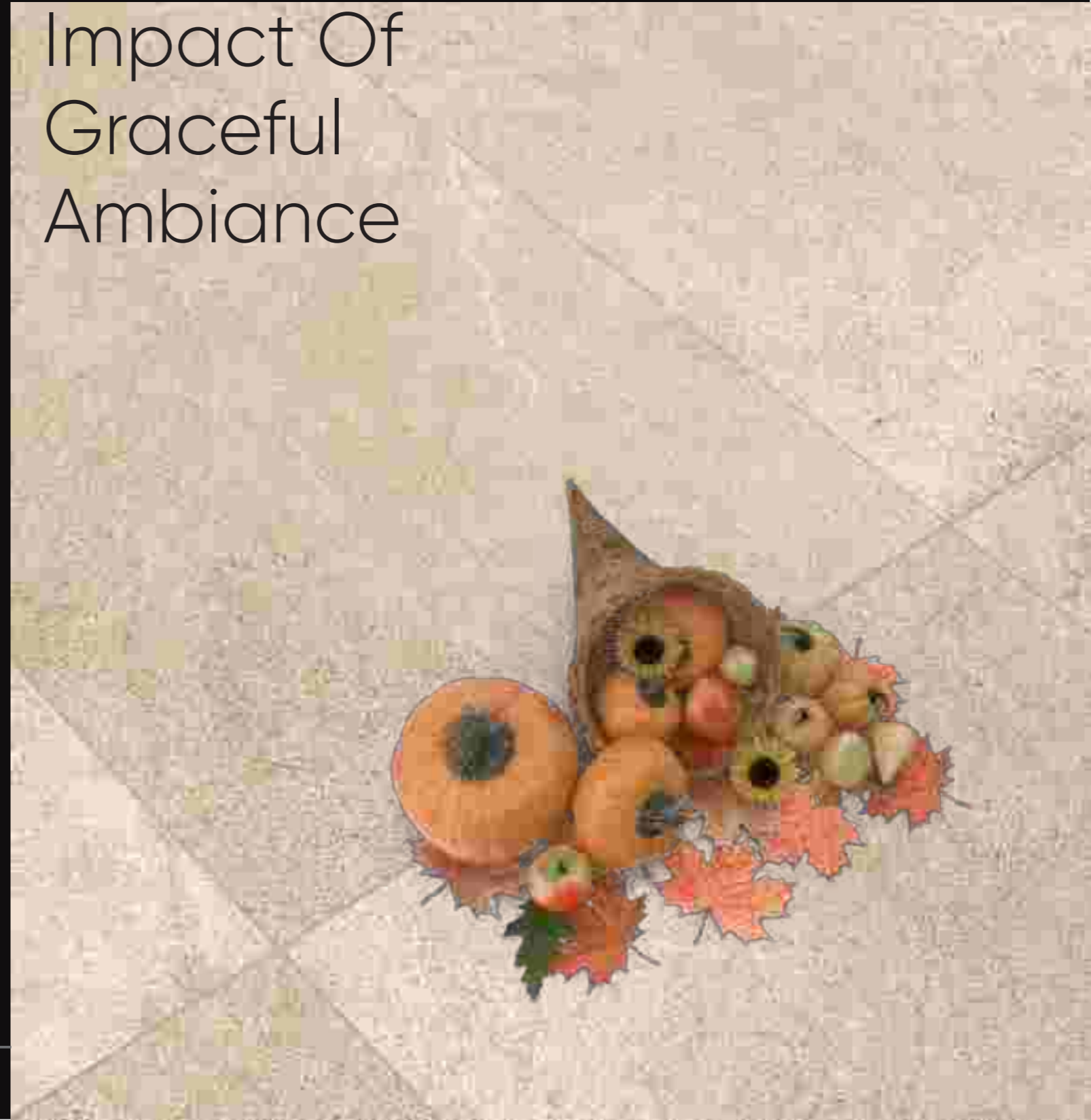



MILANO BEIGE

PERTH BEIGE

SURFACE

MATT- R09 | R11

THICKNESS

16mm | 20mm

SIZE

600x1200mm
600x900mm
600x600mm

Plain Punch
Slate Punch
Stone Punch

Random- 3



Bring
Classic Beauty
To Your Space

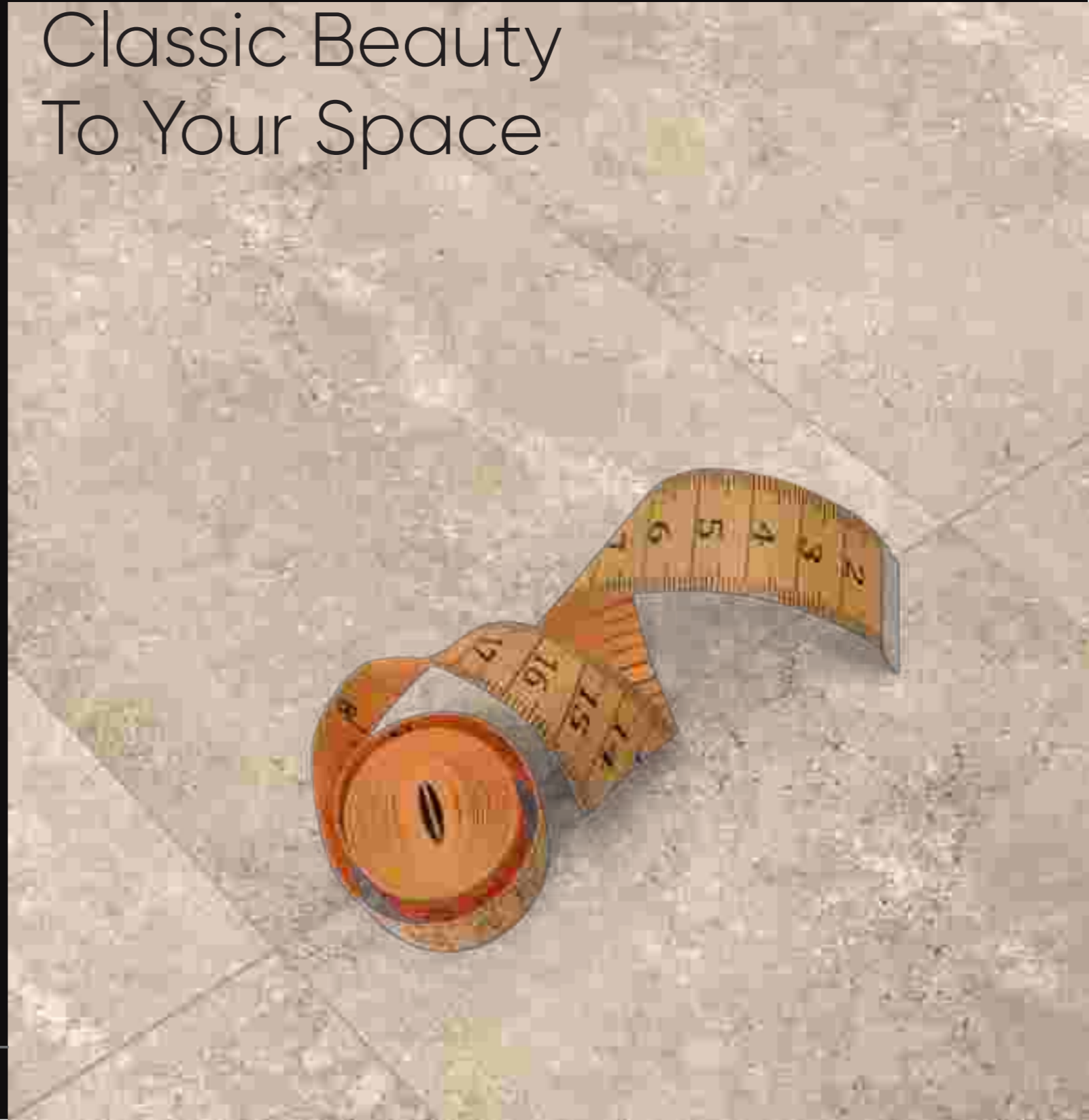



PERTH BEIGE

PERTH BIANCO

SURFACE

MATT- R09 | R11

THICKNESS

16mm | 20mm

SIZE

600x1200mm
600x900mm
600x600mm

Plain Punch
Slate Punch
Stone Punch

Random- 3



Giving The Marvelous Touch





PERTH BIANCO

PERTH CHOKO

SURFACE

MATT- R09 | R11

THICKNESS

16mm | 20mm

SIZE

600x1200mm
600x900mm
600x600mm

Plain Punch
Slate Punch
Stone Punch

Random- 3



Make
Your Space
More Shining





PERTH CHOKO

PORTO GREY

SURFACE

MATT- R09 | R11

THICKNESS

16mm | 20mm

SIZE

600x1200mm
600x900mm
600x600mm

Plain Punch
Slate Punch
Stone Punch

Random- 3



Revolutionize
Your Decor
With The Regal
Magnificence





PORTO GREY

POZZOLANA BURLY

SURFACE

MATT- R09 | R11

THICKNESS

16mm | 20mm

SIZE

600x1200mm

600x900mm

600x600mm

Random- 1

Plain Punch
Slate Punch
Stone Punch



Your
Lifestyle Define
Your Quality



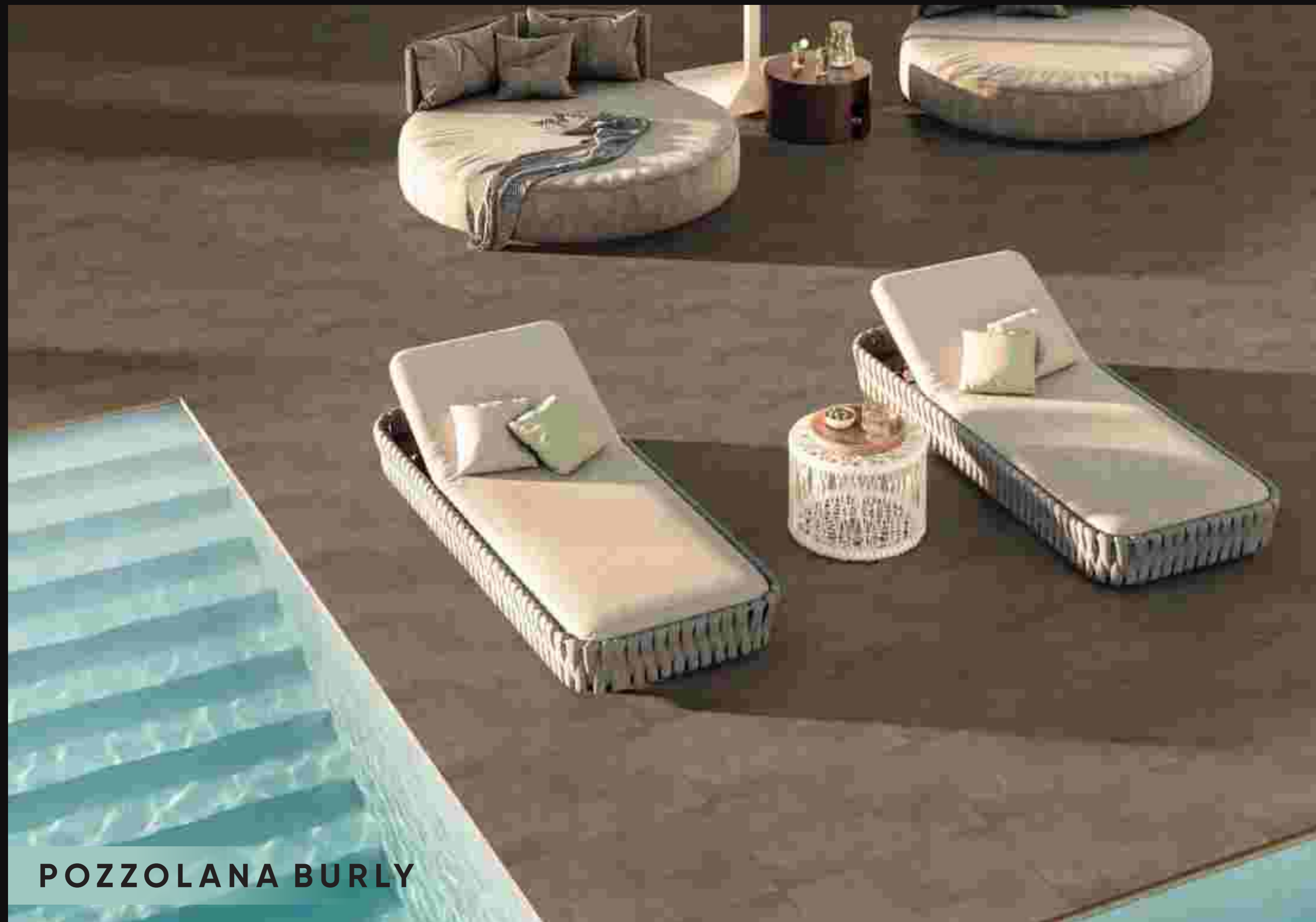

POZZOLANA BURLY

POZZOLANA GREY

SURFACE

MATT- R09 | R11

THICKNESS

16mm | 20mm

SIZE

600x1200mm
600x900mm
600x600mm

Random- 1

Plain Punch
Slate Punch
Stone Punch



The Charm Of Your Imagination





POZZOLANA GREY

POZZOLANA MARRON

SURFACE

MATT- R09 | R11

THICKNESS

16mm | 20mm

SIZE

600x1200mm

600x900mm

600x600mm

Random- 1

Plain Punch
Slate Punch
Stone Punch



New

Collection For All Season





POZZOLANA MARRON

POZZOLANA SMOKE

SURFACE

MATT- R09 | R11

THICKNESS

16mm | 20mm

SIZE

600x1200mm

600x900mm

600x600mm

Random- 1

Plain Punch
Slate Punch
Stone Punch

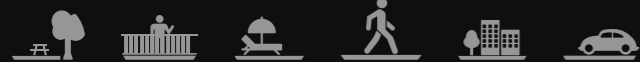

New

Collection For All Season





POZZOLANA SMOKE

ROCK BEIGE

SURFACE

MATT- R09 | R11

THICKNESS

16mm | 20mm

SIZE

600x1200mm
600x900mm
600x600mm

Plain Punch
Slate Punch
Stone Punch

Random- 3



Appealing And Stylish Collection





ROCK BEIGE

ROCK BIANCO

SURFACE

MATT- R09 | R11

THICKNESS

16mm | 20mm

SIZE

600x1200mm
600x900mm
600x600mm

Plain Punch
Slate Punch
Stone Punch

Random- 3



Add Some Sparks For Your Elegance Style

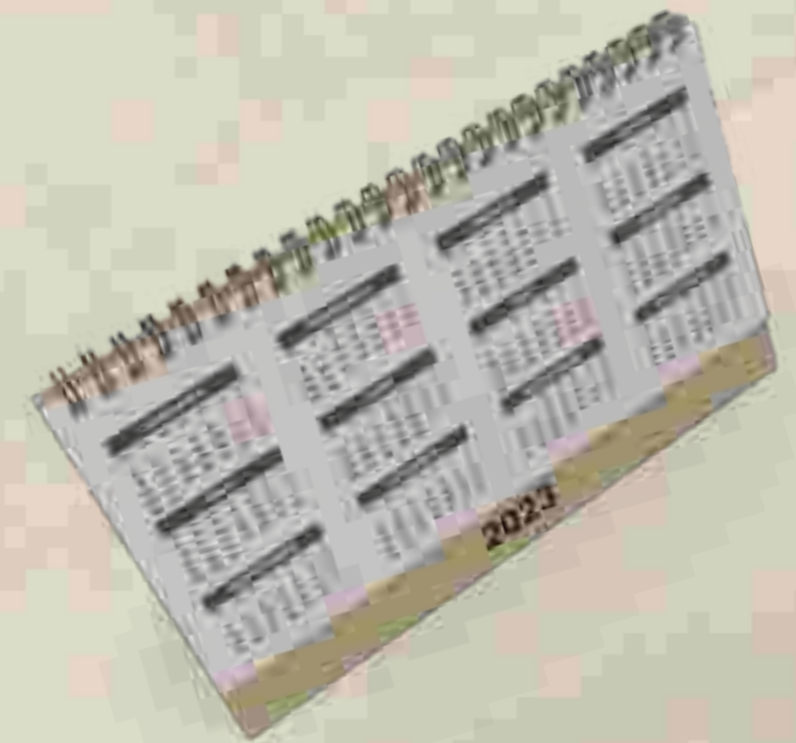



ROCK BIANCO

ROCK BROWN

SURFACE

MATT- R09 | R11

THICKNESS

16mm | 20mm

SIZE

600x1200mm
600x900mm
600x600mm

Plain Punch
Slate Punch
Stone Punch

Random- 3



Perfect
For Your
Living Style





ROCK BROWN

ROCK CEMENTO

SURFACE

MATT- R09 | R11

THICKNESS

16mm | 20mm

SIZE

600x1200mm
600x900mm
600x600mm

Plain Punch
Slate Punch
Stone Punch

Random- 3



Creation And Imagination Together





ROCK CEMENTO

ROCK GRIS

SURFACE

MATT- R09 | R11

THICKNESS

16mm | 20mm

SIZE

600x1200mm
600x900mm
600x600mm

Plain Punch
Slate Punch
Stone Punch

Random- 3



Create

Some Simplicity Style





ROCK GRIS

ROCK NATURAL

SURFACE

MATT- R09 | R11

THICKNESS

16mm | 20mm

SIZE

600x1200mm
600x900mm
600x600mm

Plain Punch
Slate Punch
Stone Punch

Random- 3



Collection Of New Innovation Style



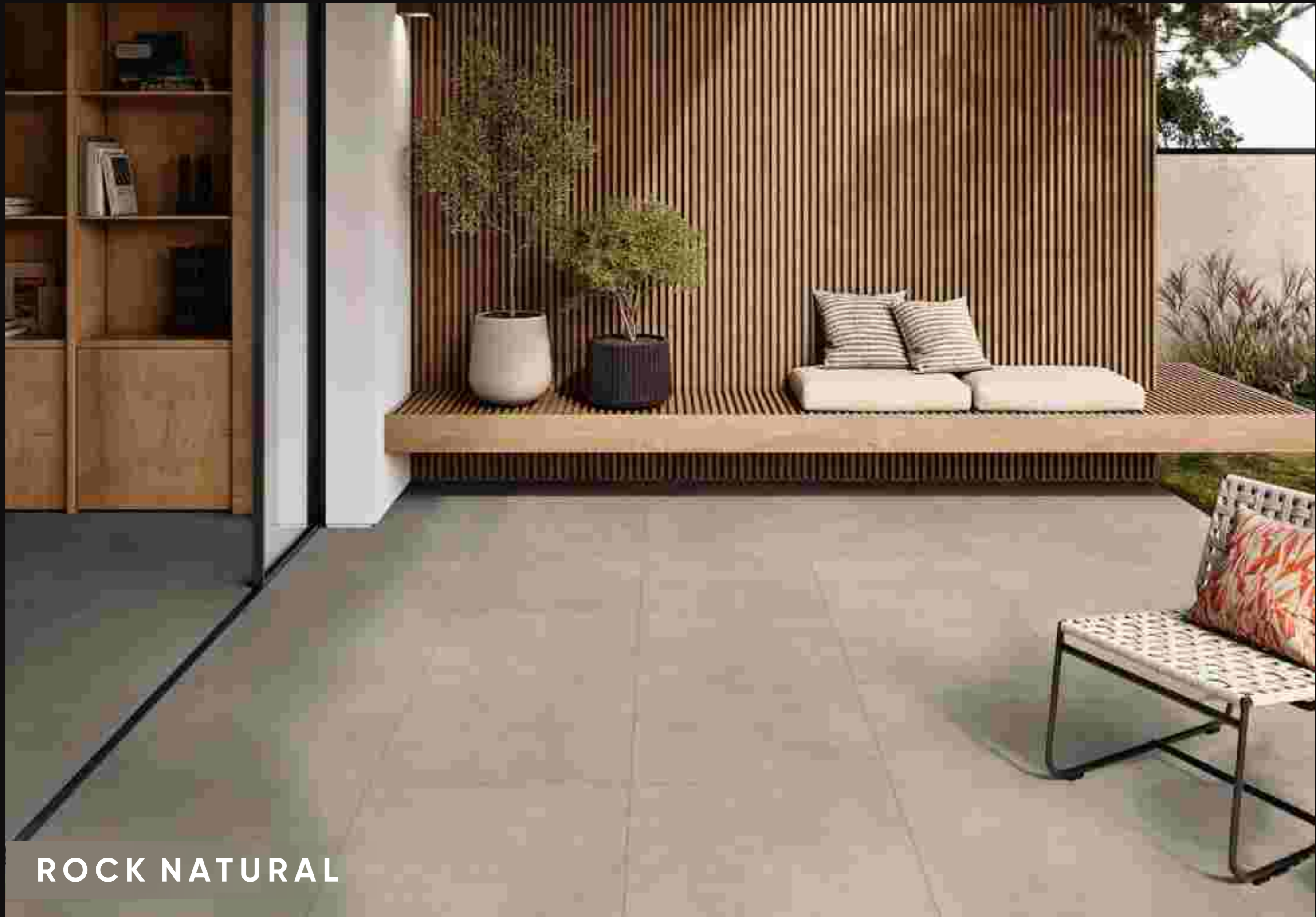

ROCK NATURAL

ROCK TAUPE

SURFACE

MATT- R09 | R11

THICKNESS

16mm | 20mm

SIZE

600x1200mm
600x900mm
600x600mm

Plain Punch
Slate Punch
Stone Punch

Random- 3



The Charm Of Living Style





ROCK TAUPE

ROME BEIGE

SURFACE

MATT- R09 | R11

THICKNESS

16mm | 20mm

SIZE

600x1200mm
600x900mm
600x600mm

Plain Punch
Slate Punch
Stone Punch

Random- 3

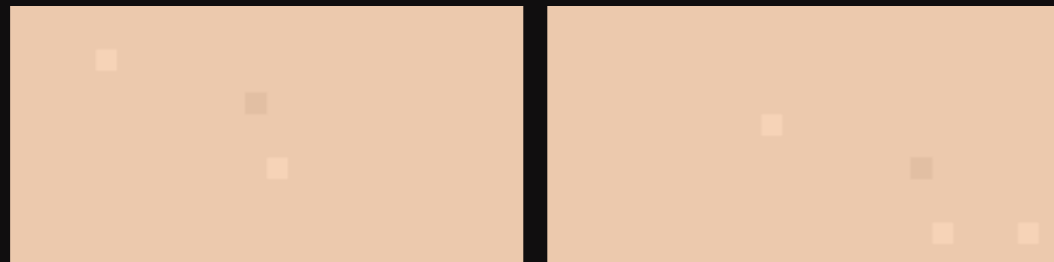

Attitude

Is A Part Of Every Day

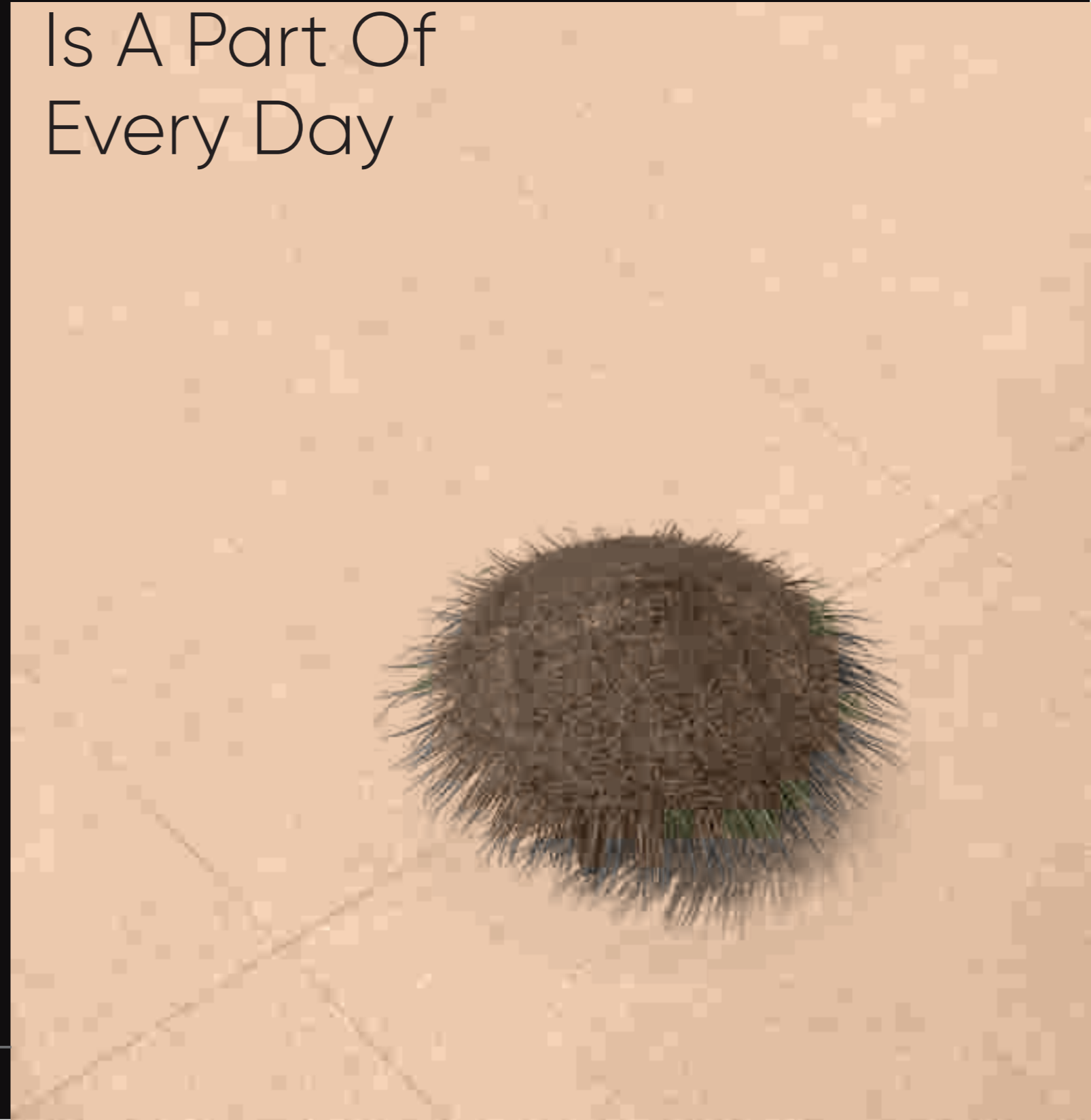



ROME BEIGE

ROME BIANCO

SURFACE

MATT- R09 | R11

THICKNESS

16mm | 20mm

SIZE

600x1200mm
600x900mm
600x600mm

Plain Punch
Slate Punch
Stone Punch

Random- 3



Every
Space Deserve
Attention





ROME BIANCO

ROME DARK GREY

SURFACE

MATT- R09 | R11

THICKNESS

16mm | 20mm

SIZE

600x1200mm
600x900mm
600x600mm

Plain Punch
Slate Punch
Stone Punch

Random- 3



Create
Something
Unique





ROME DARK GREY

ROME LIGHT GREY

SURFACE

MATT- R09 | R11

THICKNESS

16mm | 20mm

SIZE

600x1200mm
600x900mm
600x600mm

Plain Punch
Slate Punch
Stone Punch

Random- 3



100

Same
Comfort
New Look

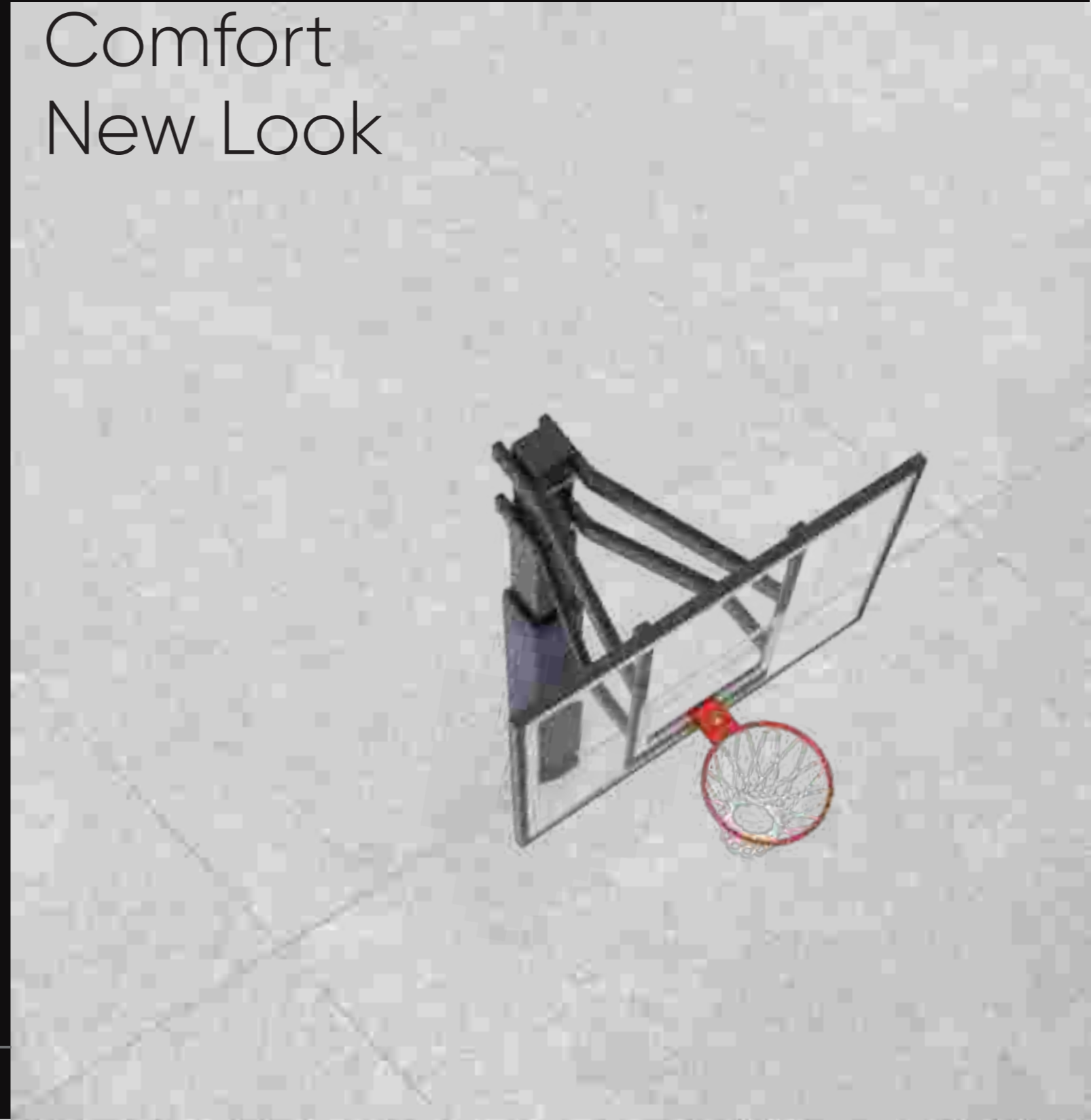



ROME LIGHT GREY

SWISS DARK

SURFACE

MATT- R09 | R11

THICKNESS

16mm | 20mm

SIZE

600x1200mm
600x900mm
600x600mm

Plain Punch
Slate Punch
Stone Punch

Random- 3



Say

Yes To Your Stylish Look





SWISS DARK

SWISS LIGHT

SURFACE

MATT- R09 | R11

THICKNESS

16mm | 20mm

SIZE

600x1200mm
600x900mm
600x600mm

Plain Punch
Slate Punch
Stone Punch

Random- 3



The Feeling Of Forest Wood

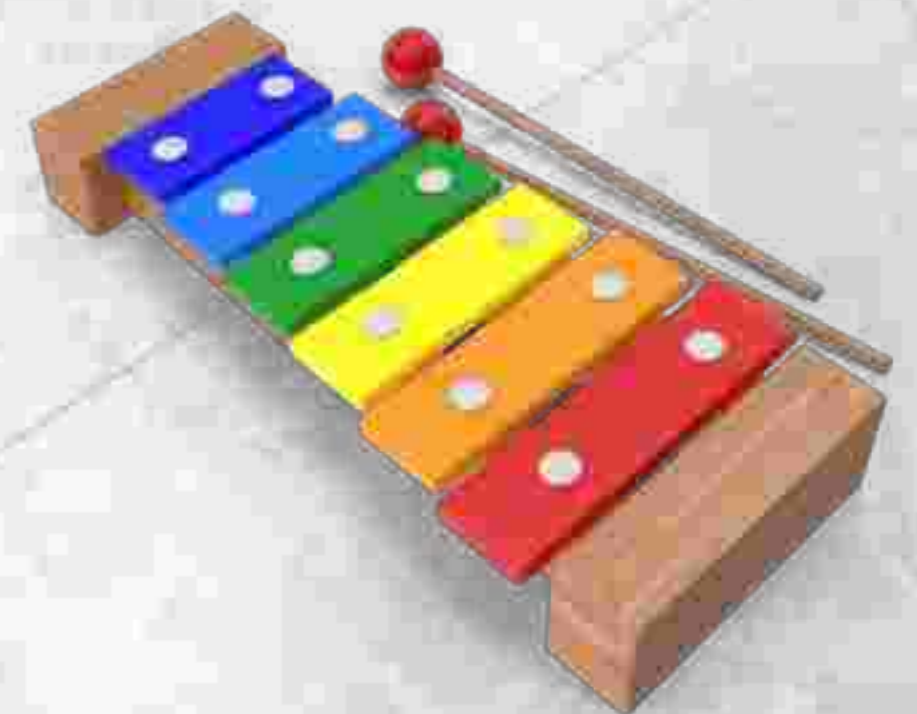



SWISS LIGHT

VENICE BIANCO

SURFACE

MATT- R09 | R11

THICKNESS

16mm | 20mm

SIZE

600x1200mm
600x900mm
600x600mm

Plain Punch
Slate Punch
Stone Punch

Random- 3



Live

With Adorable Space

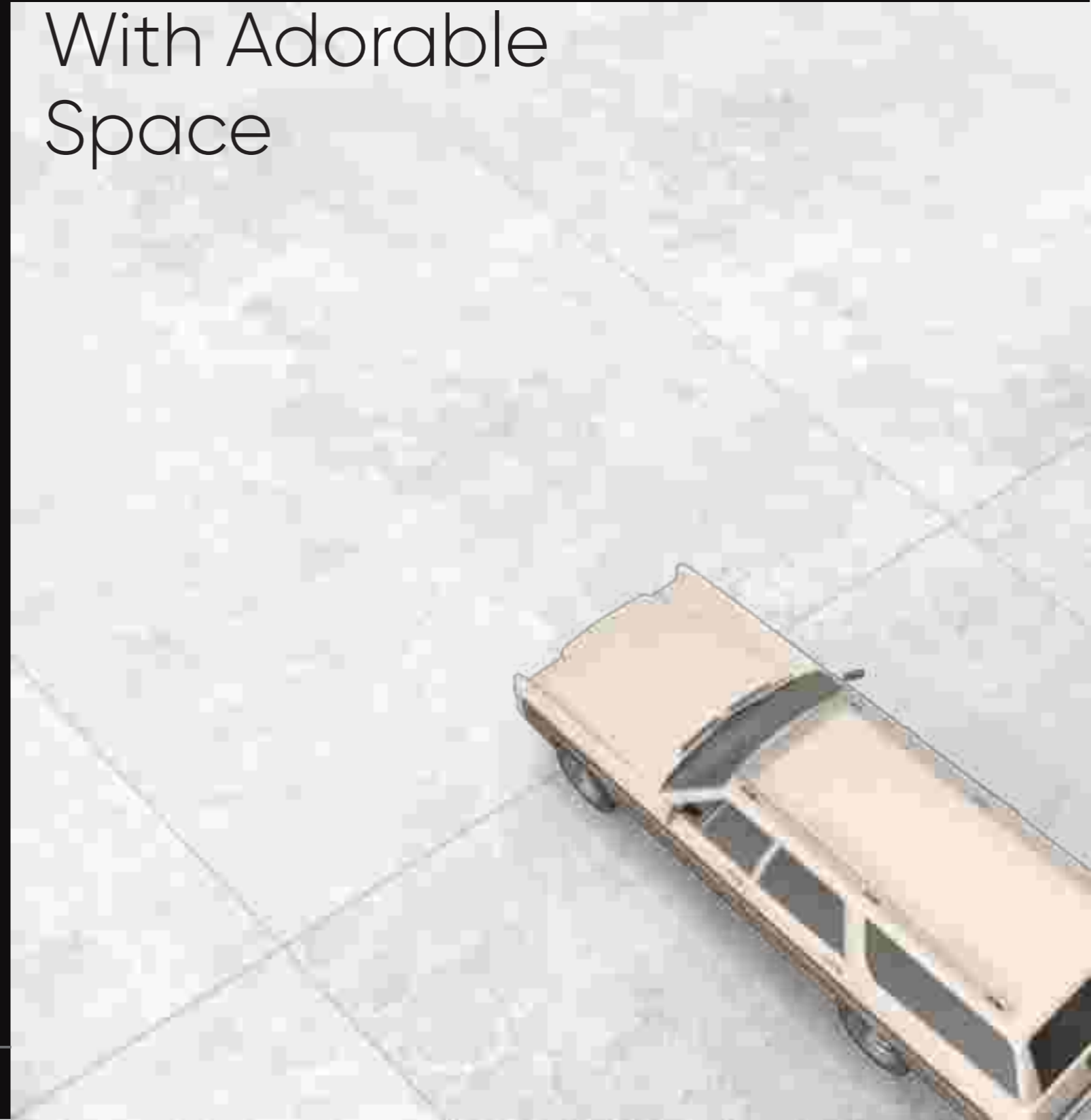



VENICE BIANCO

VENICE BLUE

SURFACE

MATT- R09 | R11

THICKNESS

16mm | 20mm

SIZE

600x1200mm
600x900mm
600x600mm

Plain Punch
Slate Punch
Stone Punch

Random- 3

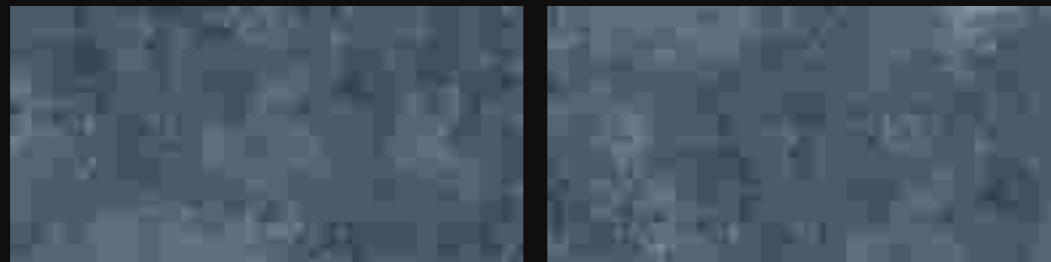

Creation
Is The Power
Of Art





VENICE BLUE

VENICE GREEN

SURFACE

MATT- R09 | R11

THICKNESS

16mm | 20mm

SIZE

600x1200mm
600x900mm
600x600mm

Plain Punch
Slate Punch
Stone Punch

Random- 3



Unique For Your Home





VENICE GREEN

VENICE GREY

SURFACE

MATT- R09 | R11

THICKNESS

16mm | 20mm

SIZE

600x1200mm
600x900mm
600x600mm

Plain Punch
Slate Punch
Stone Punch

Random- 3

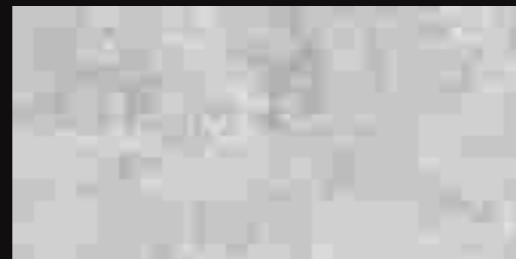
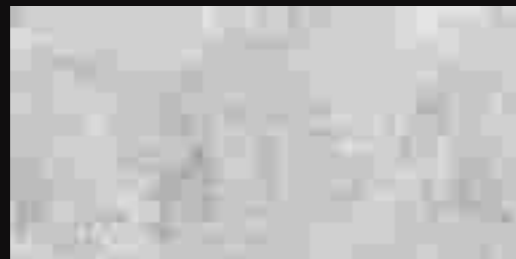

Class

Act Like
A Anchor



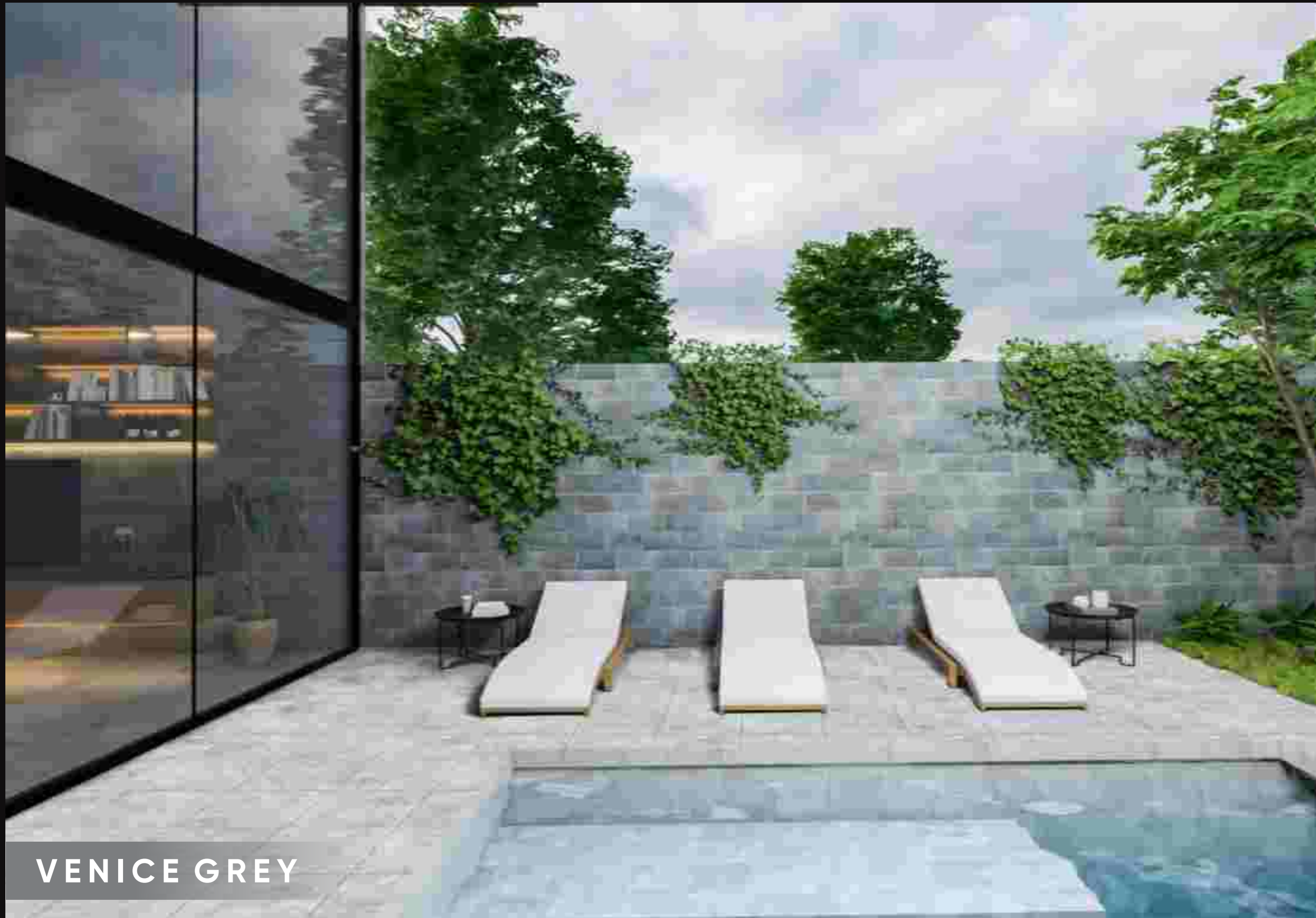

VENICE GREY

VIENNA SILK

SURFACE

MATT- R09 | R11

THICKNESS

16mm | 20mm

SIZE

600x1200mm
600x900mm
600x600mm

Plain Punch
Slate Punch
Stone Punch

Random-2



The Best Look Of Summer Season



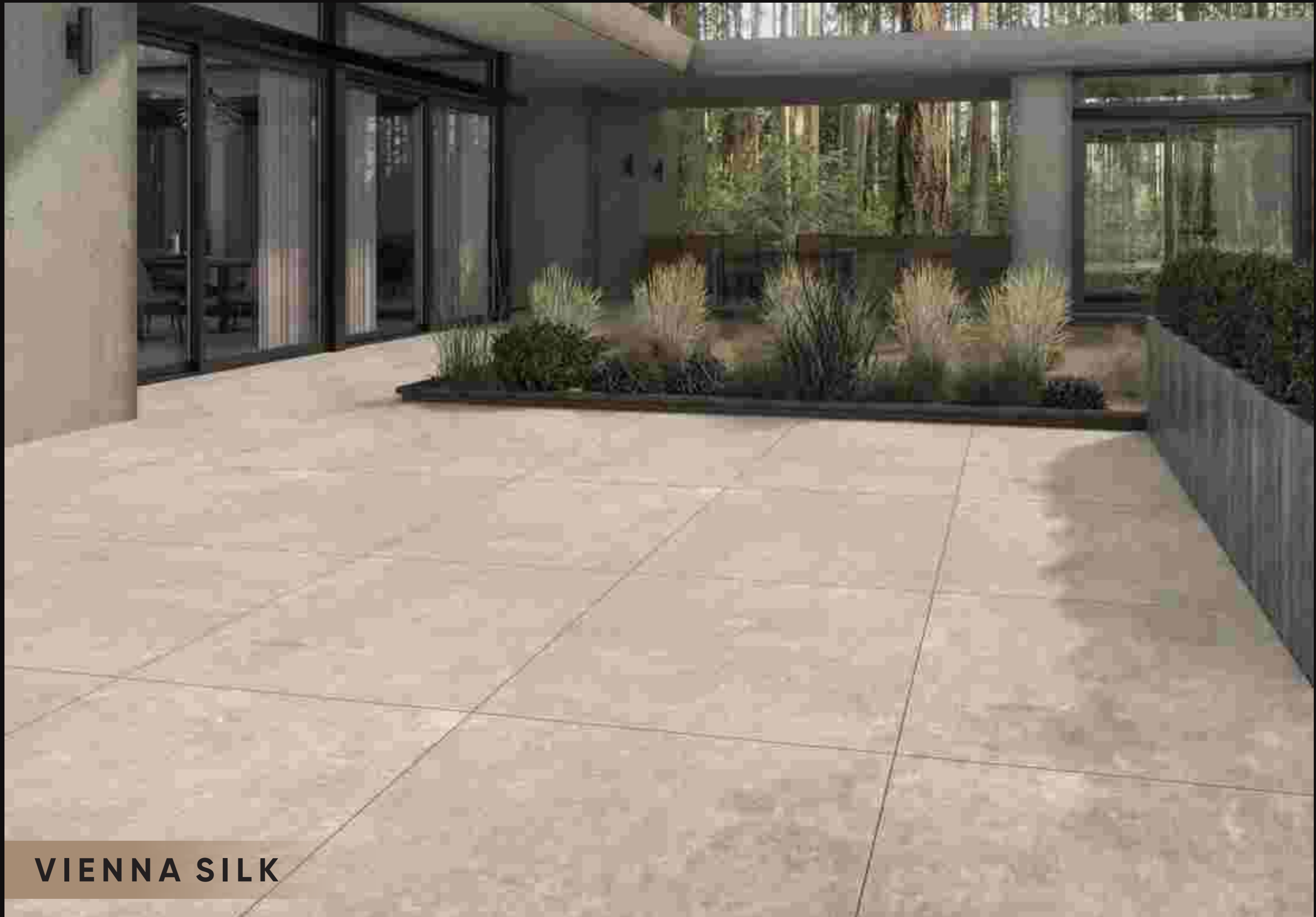

VIENNA SILK

VOLGA BIANCO

SURFACE

MATT- R09 | R11

THICKNESS

16mm | 20mm

SIZE

600x1200mm
600x900mm
600x600mm

Plain Punch
Slate Punch
Stone Punch

Random- 3



To Be

Perfect , To
Be Wonderful



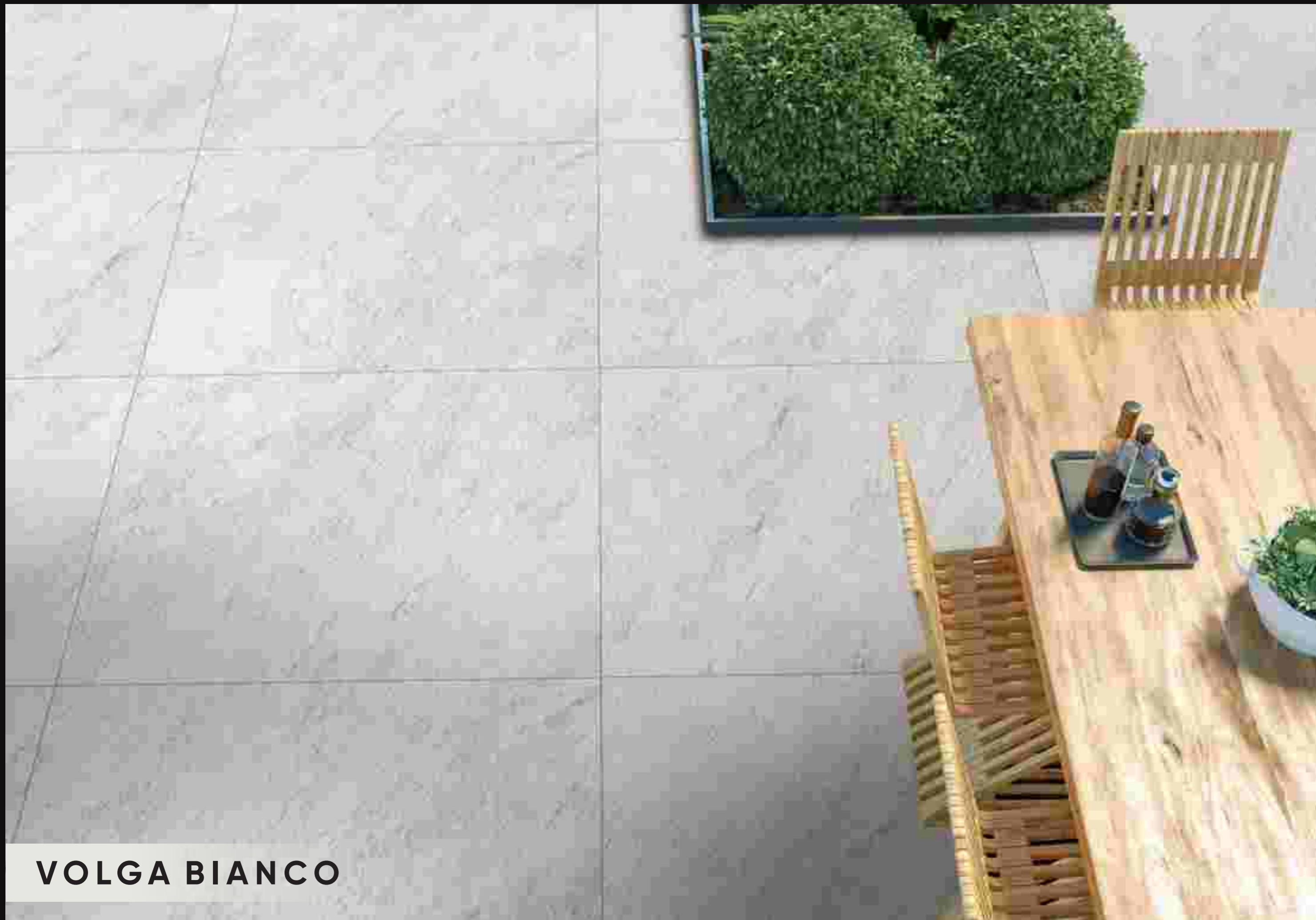

VOLGA BIANCO

VOLGA SILK

SURFACE

MATT- R09 | R11

THICKNESS

16mm | 20mm

SIZE

600x1200mm
600x900mm
600x600mm

Plain Punch
Slate Punch
Stone Punch

Random- 3



Stone

Is The Necessity Of Life





VOLGA SILK

HAMMER STONE BEIGE

SURFACE

MATT- R09 | R11

THICKNESS

16mm | 20mm

SIZE

600x600mm

Plain Punch
Slate Punch
Stone Punch

Random- 5

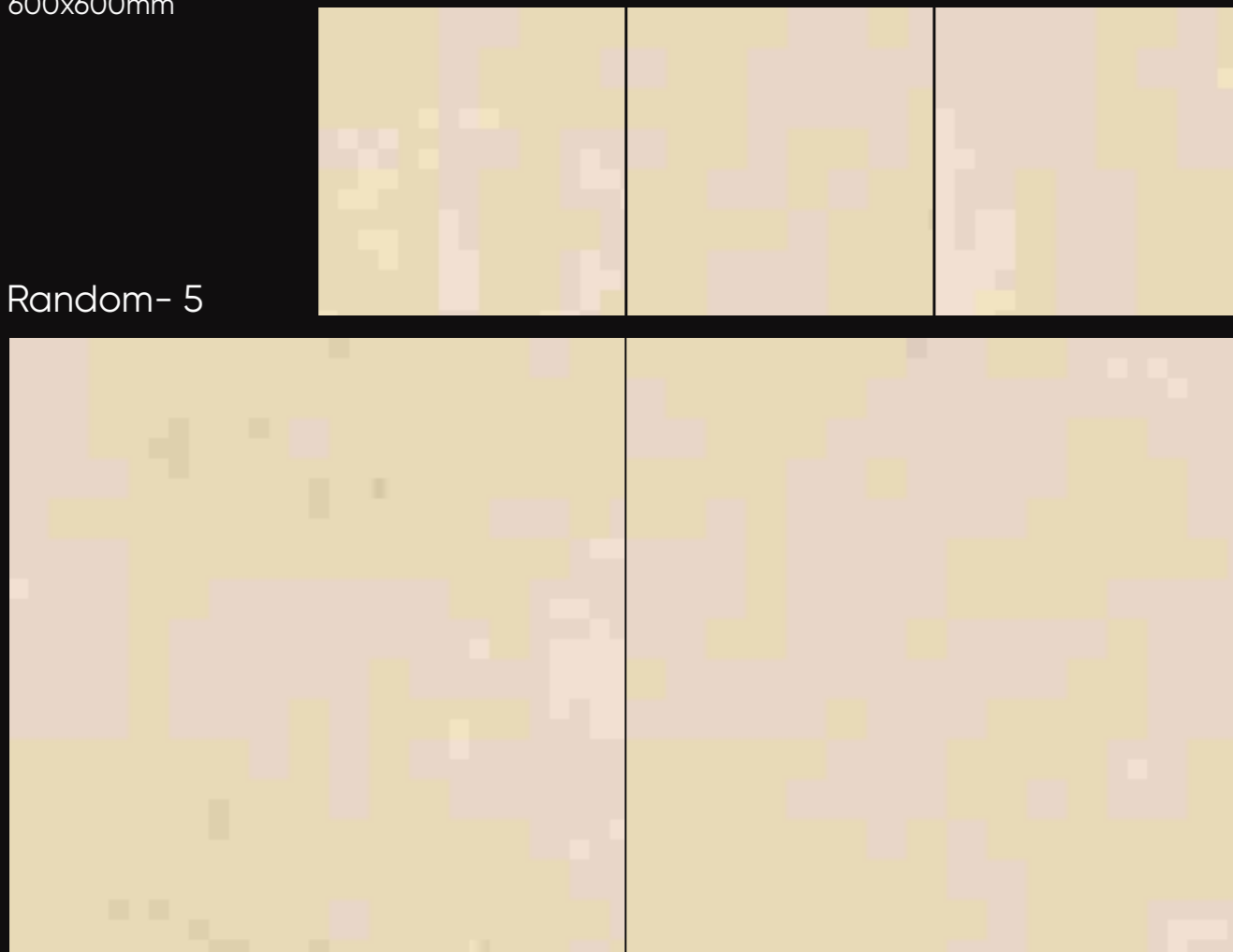

To Be

Perfect , To Be Wonderful





HAMMER STONE BEIGE

LAVA STONE

SURFACE

MATT- R09 | R11

THICKNESS

16mm | 20mm

SIZE

600x600mm

Random- 3

Plain Punch
Slate Punch
Stone Punch



To Be

Perfect , To Be Wonderful





LAVA STONE

QUARTZ GREY

SURFACE

MATT- R09 | R11

THICKNESS

16mm | 20mm

SIZE

600x600mm

Plain Punch
Slate Punch
Stone Punch

Random- 5

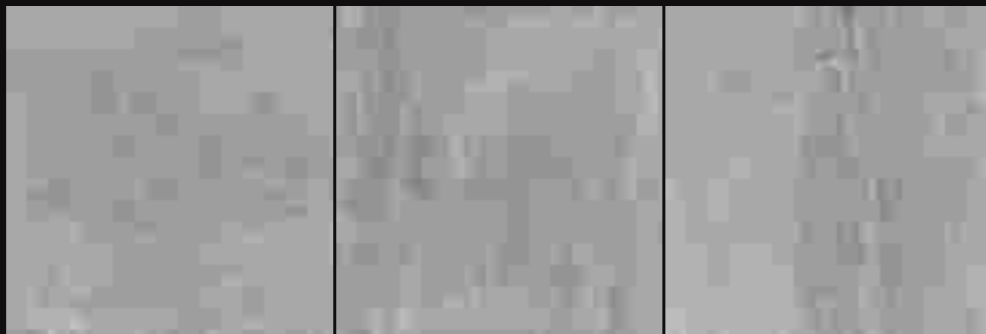

To Be

Perfect , To Be Wonderful





QUARTZ GREY

QUARTZ WHITE

SURFACE

MATT- R09 | R11

THICKNESS

16mm | 20mm

SIZE

600x600mm

Plain Punch
Slate Punch
Stone Punch

Random- 3



To Be

Perfect , To Be Wonderful





QUARTZ WHITE

SHERPA BEIGE

SURFACE

MATT- R09 | R11

THICKNESS

16mm | 20mm

SIZE

600x600mm

Plain Punch
Slate Punch
Stone Punch

Random- 5



To Be

Perfect , To Be Wonderful





SHERPA BEIGE

SHERPA GREY

SURFACE

MATT- R09 | R11

THICKNESS

16mm | 20mm

SIZE

600x600mm

Plain Punch
Slate Punch
Stone Punch

Random- 3



To Be

Perfect , To Be Wonderful





SHERPA GREY

OUTDOOR
PORCELAIN TILES

PORCELAIN STONEWARE TILE 20MM FOR OUTDOOR FLOORING

20mm outdoor porcelain stoneware is the product with the highest technical performance, ideal for flooring in an outdoor environment without the risk of breakage and without interrupting the continuity between interior and exterior spaces. Resistant to frost and thermal

shock, it has intensified anti-slip characteristics and is easy to clean. The perfect union between high technical performance and aesthetics helps maintain the material and color unchanged over time, guaranteeing long-lasting durability.

VERSATILE

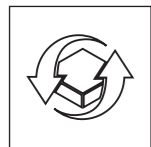

Easy To Lay,
Remove And Reuse

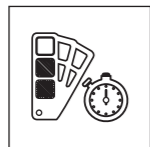

Colors Remain
Stable Over Time

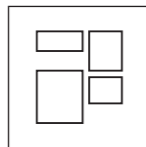

Outdoor And
Indoor Flooring



Attention To Detail

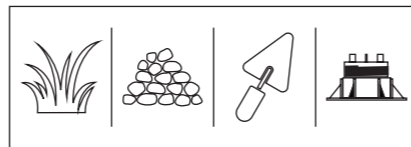

Can Be Installed With Different
Laying Systems

RESISTANT

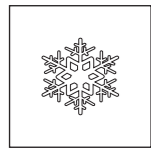

Frost-Resistant



Fire-proof

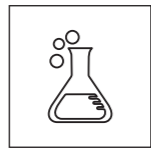

Resistant To Stains,
Chemical Agents

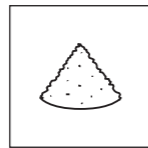

Resistant To Salt



Resistant To Salt

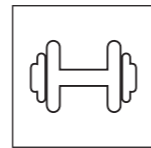

Highly Resistant
To Heavy Load

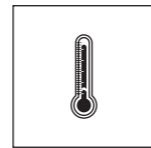

High Resistance
To Thermal Shock

FUNCTIONAL

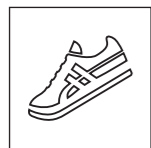

Non-slip Surfaces

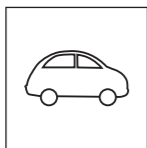

Resistant To
Vehicular Passage
If Applied To A Screed

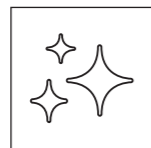

ECO-FRIENDLY

ECO-FRIENDLY



Eco-friendly



Leed Compliant

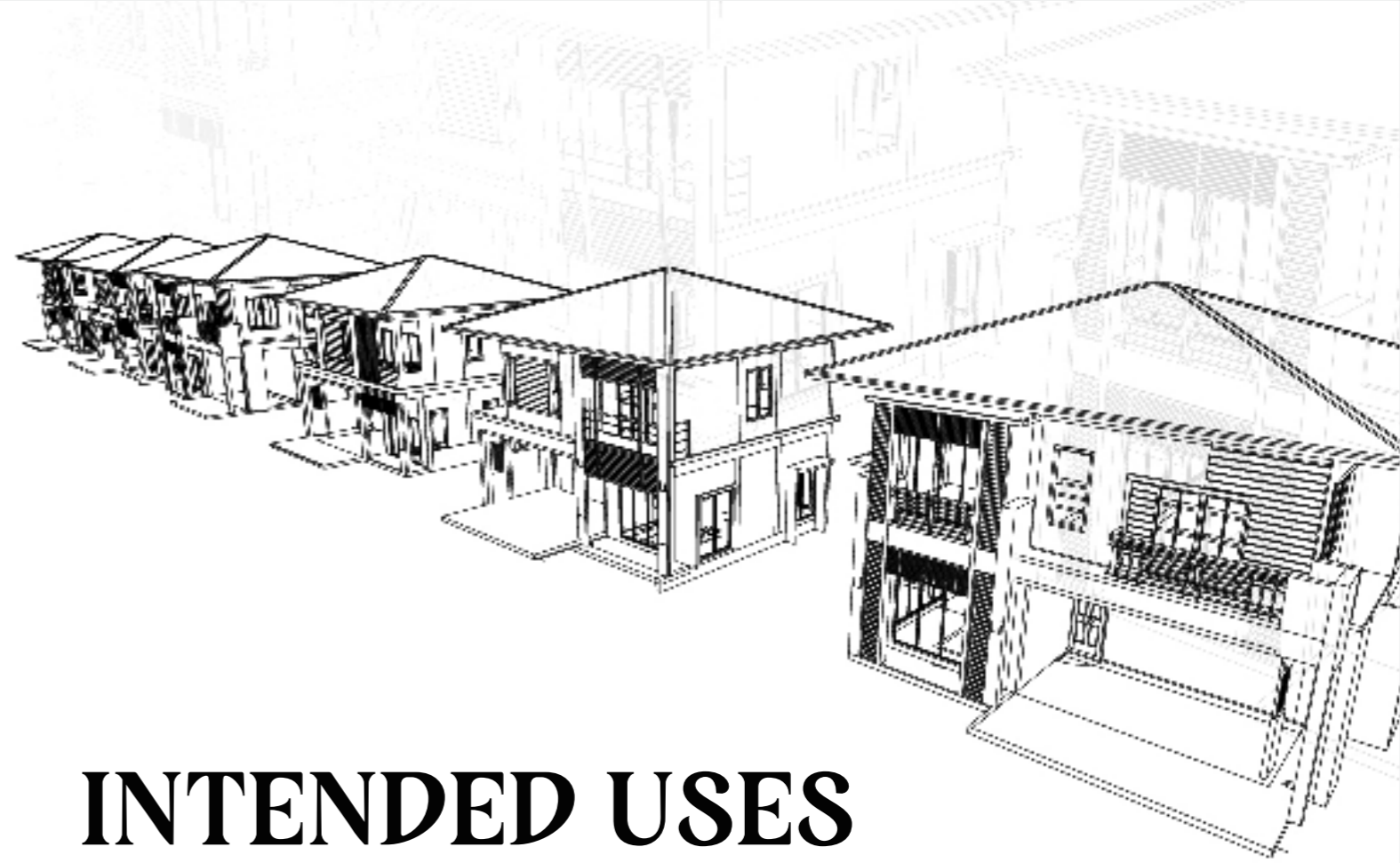

INTENDED USES

PORCELAIN STONEWARE TILE 20MM FOR OUTDOOR FLOORING

Owing to the possibility of installing it dry (on grass, sand, gravel, and elevated floors) the 20mm porcelain outdoor tile collection is the most versatile solution for exterior floors in residential and public areas.

OUTDOOR
PORCELAIN TILES

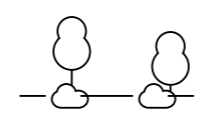

1 DRIVEWAYS AND
PATHWAYS

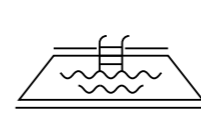

2 SWIMMING POOLS, SPAS
AND ADJOINING AREAS



3 URBAN FURNITURE
AND PUBLIC PLACES

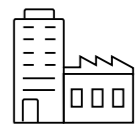

4 HIGH-TRAFFIC
INDUSTRIAL ZONES

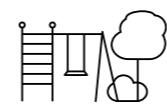

5 PUBLIC PARKS
AND GARDENS

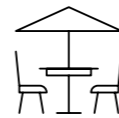

6 TERRACES AND
BALCONIES

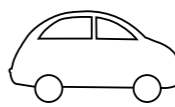

7 CAR PARKS
AND DRIVEWAY AREAS



OTHER APPLICATION
SOLUTIONS

OUTDOOR PORCELAIN TILES

LAYING SOLUTIONS

Outdoor Porcelain 20mm Tiles Are An Innovative Solution That Is Very Versatile Due To The Numerous Laying Possibilities They Offer: Dry Installation On Grass, Gravel, Or Sand, Screed With Adhesive, And Elevated Floor Installation.

DRY INSTALLATION ON GRASS



A

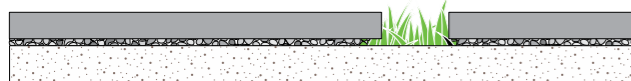

Easy to lay, adjust, and move. An ideal solution for public parks and private gardens

INSTALLATION ON SCREED WITH ADHESIVE



C



Build resilient and durable outdoor spaces, pathways, driveways, and more with the installation of 20mm tiles on screed with adhesive.

DRY INSTALLATION ON GRAVEL / SAND



B

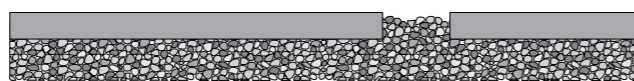

Easy to lay, adjust, and move. Boasts ideal aesthetic features to enhance contemporary buildings.

ELEVATED FLOOR INSTALLATION

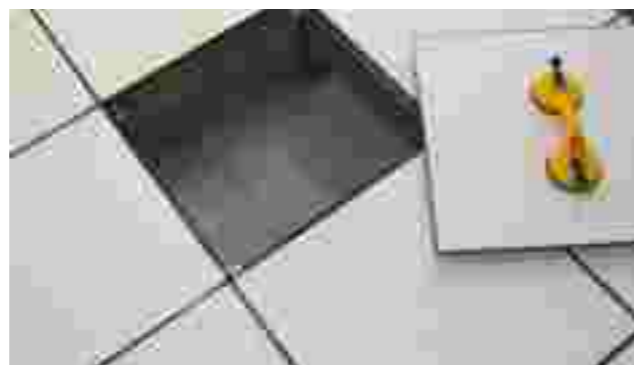

D



Easily removable, inspectible, and reusable. Ideal to be applied with different kinds of support and is apt for concealing wiring pipes, and more with accessibility.

CAUTION

- When carrying out an elevated floor installation it is recommended to check the intended use and to follow the installation instructions.
- It is recommended that the designer/client always check the suitability of the installation system selected according to local regulations in force. Failure to follow the above recommendations may result in misuse of the product and cause injury to persons and/or damage to property.

DRY INSTALLATION ON GRASS

To create a pathway with stepping stones, first of all, it is important to determine the number of steps necessary for the entire path, making sure that the tiles are positioned equidistantly. So as to obtain maximum stability, it is recommended to dig out about 5/8cm from the soil, and then place a fine layer of gravel. Compact the substrate and then position the tile. To allow the turf to grow well, it is advisable to leave a gap of at least 10cm between one tile and another.

RESISTANT

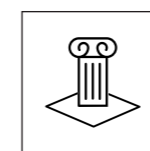

SAFE AND STABLE

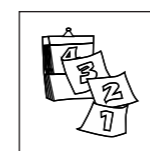

LONG-LASTING

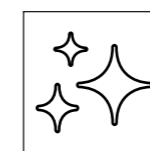

EASY TO CLEAN

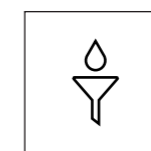

DRAINS

It Is Good Practice To Lay The Surface Of The Tiles In Line With The Turf: This Way There Is No Risk Of Damaging The Lawn Mowers

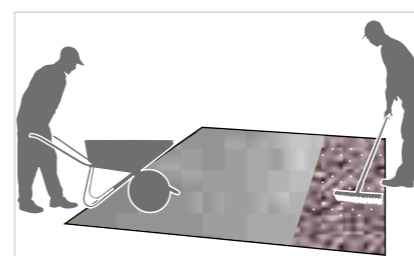
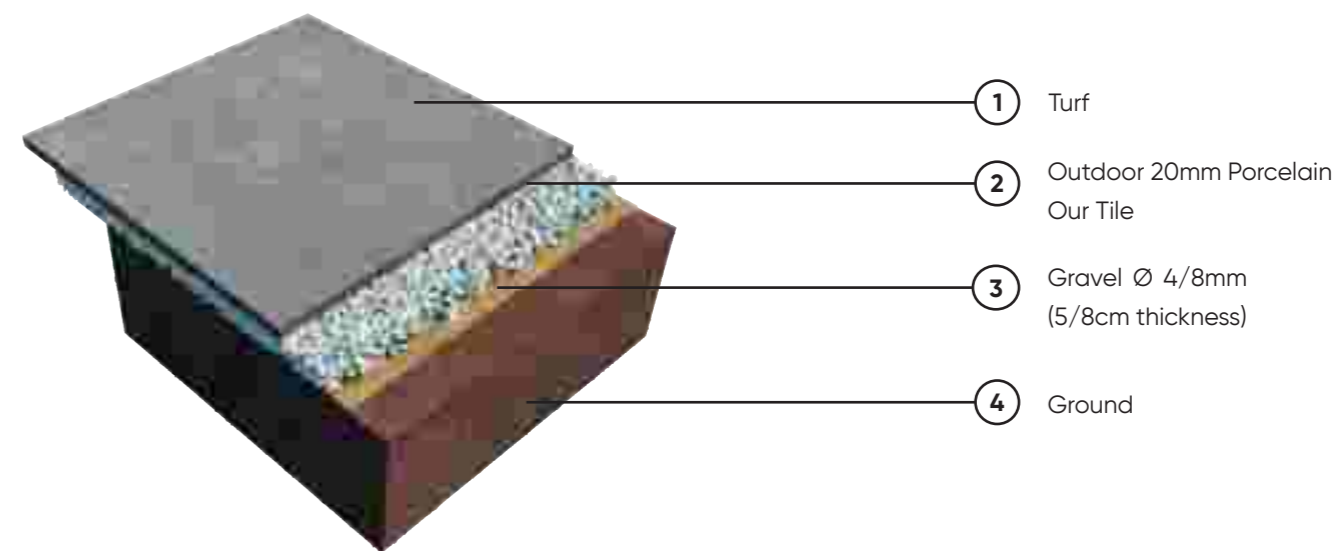

To determine the correct sizing and positioning of the flooring, place the tiles on the ground and carefully position them equidistant from each other. Mark the perimeter of the tile using a spade in the soil.

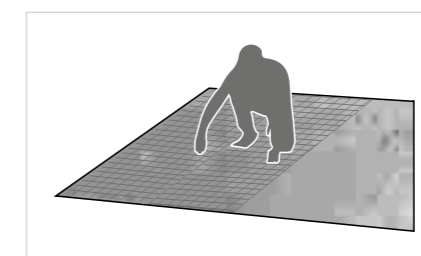

Remove the turf and dig out about 5cm of soil. Form a stable and uniform substrate using fine gravel (grain size 4/8mm).

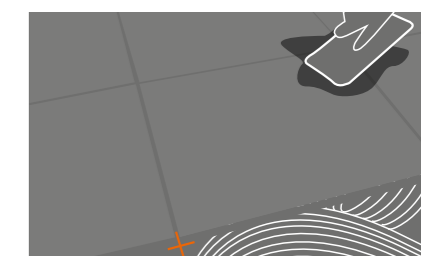

Lay the tile, so as to have an approximately 0.5cm level difference, between the tile and the ground. To simplify tile installation it is possible to use suitable tile installation handles. Knock the tile along the edges with a rubber hammer until it is at the same level as the turf.

CAUTION

The application layers proposed are to be taken as an indication, and have the sole purpose of showing how to obtain a correct flooring.

OUTDOOR
PORCELAIN TILES

DRY INSTALLATION ON GRAVEL / SAND

For installation on sand it is good to remember to place a geotextile on the gravel, on which to spread out a layer (from 2 to 5cm thick) of dry sand with a grain size of 0/2mm. It is necessary to compact the sand with a vibro-compacting plate before proceeding with the installation of the tiles. For particular uses and for stressful loads, it is advisable to consult a technician in order to calculate precisely the thicknesses of the various layers of the substrate.

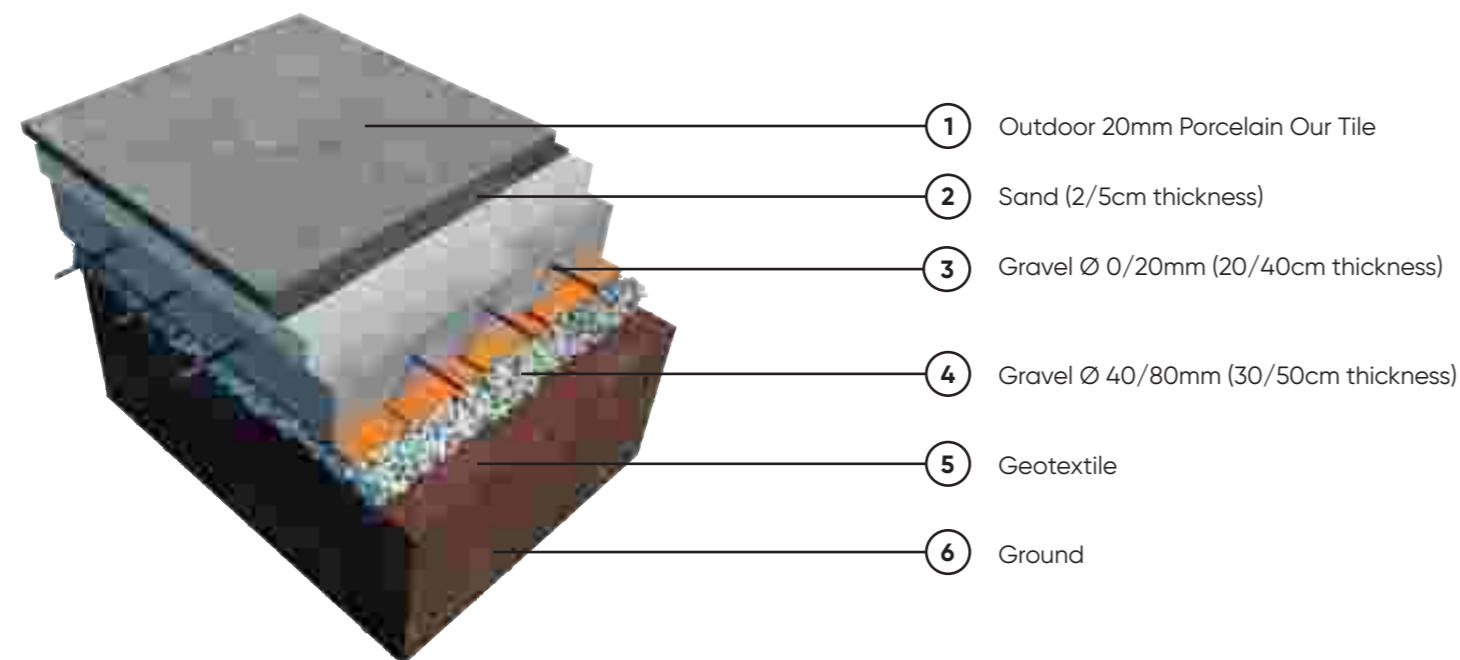
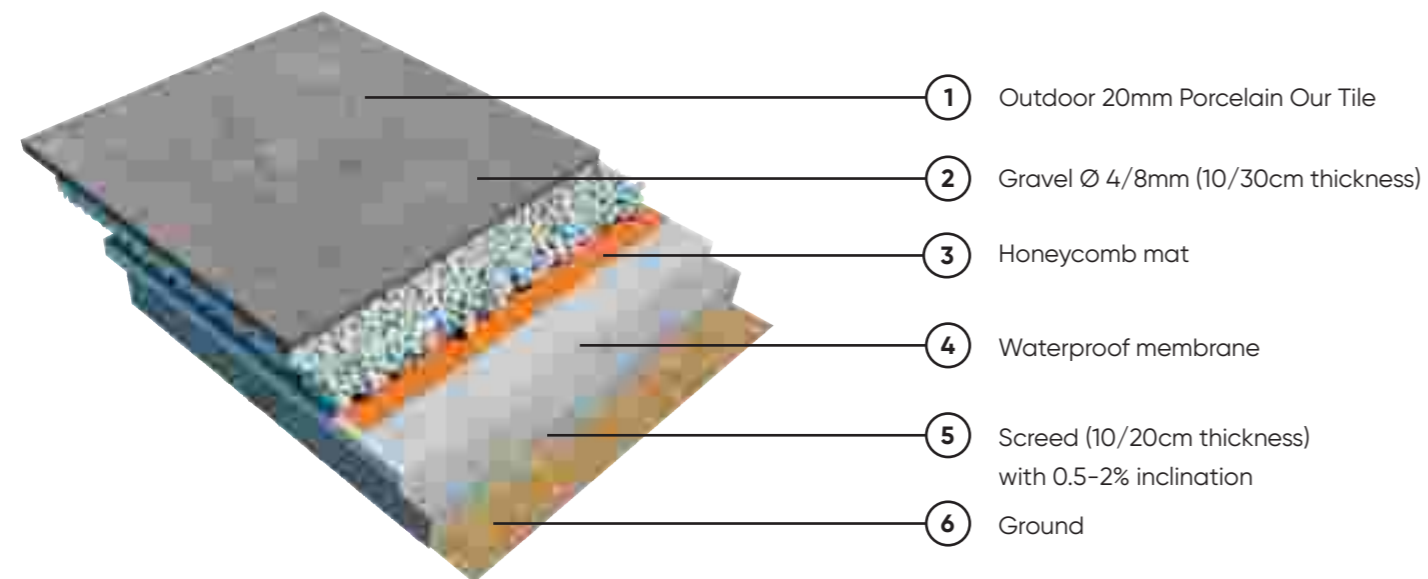

CAUTION

The application layers proposed are to be taken as an indication, and have the sole purpose of showing how to obtain a correct flooring. It is recommended to always refer to the specific norms and regulations in each individual country and the instructions of the project supervisor.

DRY INSTALLATION ON GRAVEL / SAND

In Order To Avoid The Displacement Of The Substrate And Consequently The Tiles, The Substrate Must Be Partitioned With Containment Edges Or Perimeter Curbs.



Form a stable and uniform substrate using fine gravel or sand. Level the substrate with a metal straight edge.



Position the tile and then compact the edges in order to level the tile with the substrate. It is suggested to use a joint of at least 4mm to allow good water drainage.

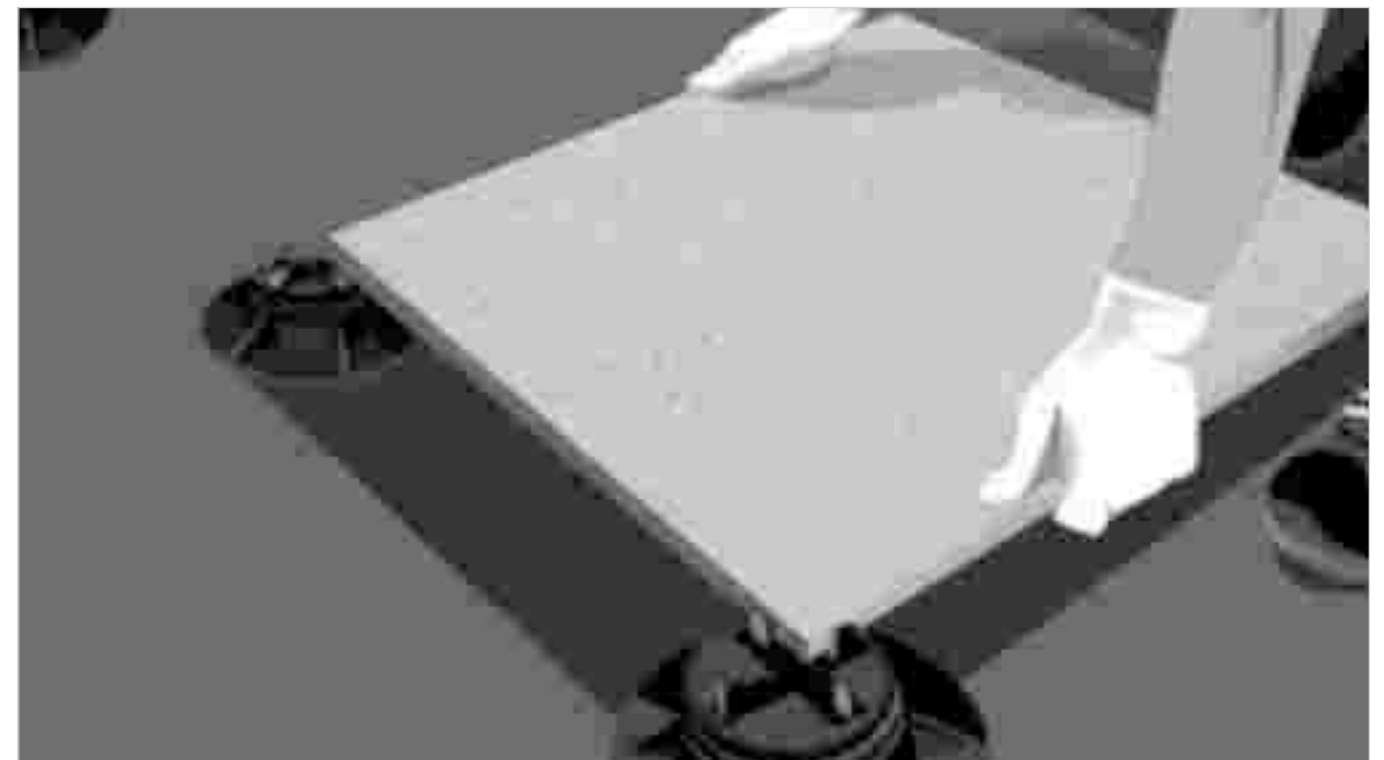

Spacers designed for laying tiles on sand or gravel are an extremely versatile and practical system despite their simplicity. The support is made up of a head with a spacer cross and a removable tip: the fins of the head cross help position the tiles and create the joint between them, ensuring that over time the flooring maintains its correct positioning. The tip is specific for application on sand: the elongated shape guarantees the anchorage and stability of the tiles, preventing them from slipping. For use on gravel, it is possible to remove the tip and place the spacer head directly on the gravel.

ELEVATED FLOOR INSTALLATION

The elevated floor technology offers many specific and immediately perceivable advantages: it allows the passage of cables, pipes and necessary installations to be managed easily; it enables the underfloor to be inspected easily and guarantees an effective draining of Rainwater. Thanks to the presence of independent elements, elevated floors absorb expansion and structural movements, thus avoiding the formation of cracks on the waterproof embrane. The absence of the screed makes it possible to substantially reduce the weight that burdens the structures, while offering a high resistance to loads.

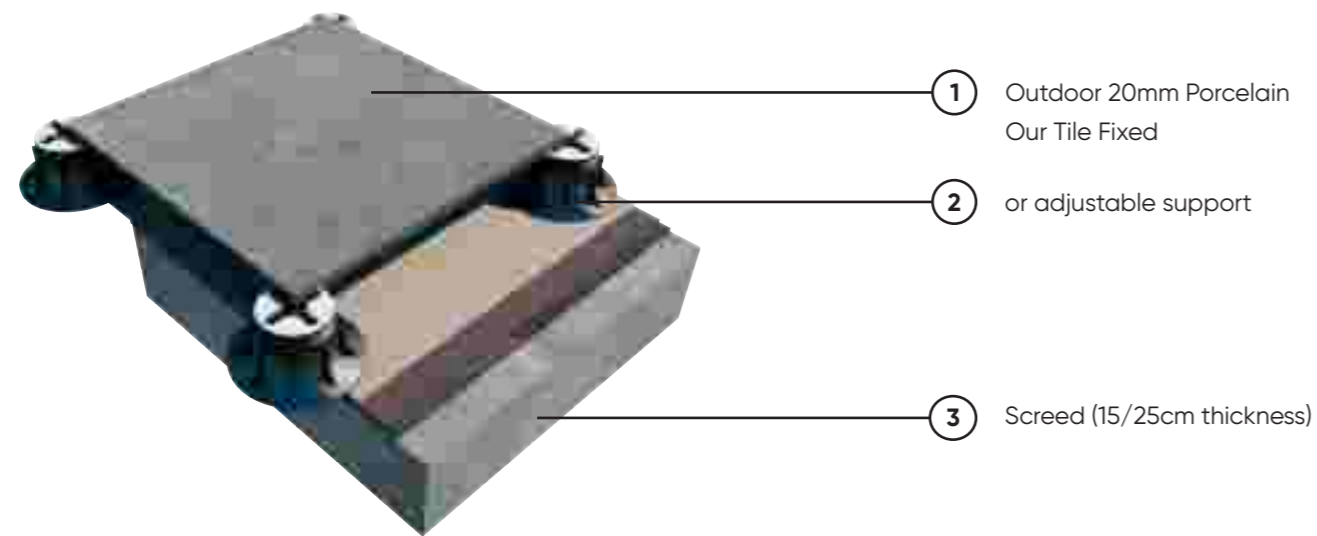

For The Optimal Drainage Of Rainwater, The Elevated Flooring Must Be Installed With A Slope Of Between 1.5% And 2%.



The installation on the plastic supports must only been done on perfectly waterproof substrates. Before proceeding with the installation clean the substrate thoroughly.



With regard to the number and position of the supports, as well as the type of reinforcement on the back of the slab, it is recommended to follow the instructions given in the following table, which are essential to evenly distribute the load.



With the use of the special adjustment key it is possible to obtain a perfectly stable surface and with the required slope for better water drainage.

CAUTION

The application layers proposed are to be taken as an indication, and have the sole purpose of showing how to obtain a correct flooring. It is recommended to always refer to the specific norms and regulations in each individual country and the instructions of the project supervisor.

ELEVATED FLOOR INSTALLATION - SUPPORTS

Fixed supports and self-levelling adjustable supports

The structure of the supports consists of a base (which rests on the slab), a central screw adjustable in height and a head (on which the tile rests) which can be fixed or self-levelling with a self-adjustment system to alter inclination by up to 5°.

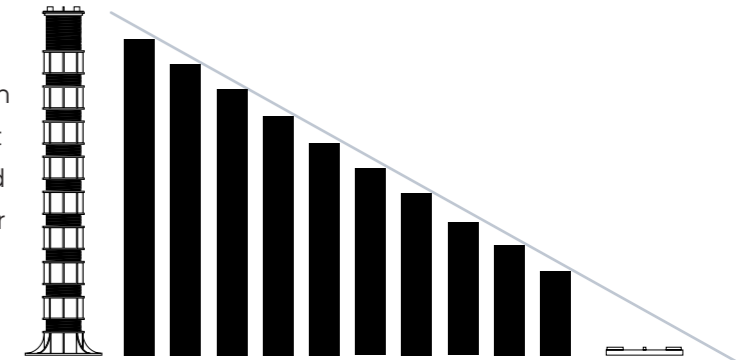

They are made entirely of recycled and recyclable material

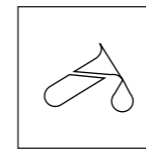

Resistant to both acidic and alkaline solutions

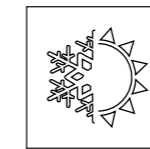

Resistant to both acidic and alkaline solutions

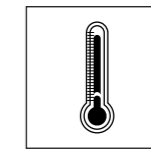

Resistant to temperatures of between -30 °C and +120°C

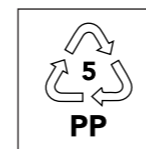

Made of polypropylene

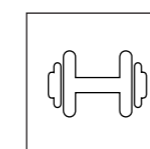

Resistant to the crushing test with a load superior to 1 tonne



Noise reduction of up to 25dB



Possibility of using supports made with self-extinguishing material, which prevents the propagation of flames

Format 60x60cm

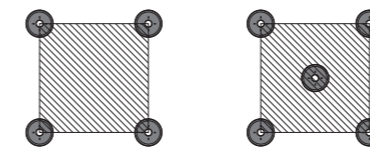

Format 60x90cm

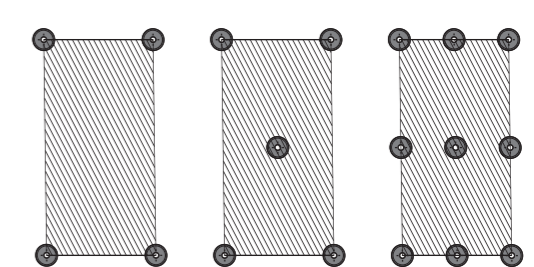

Format 60x90cm

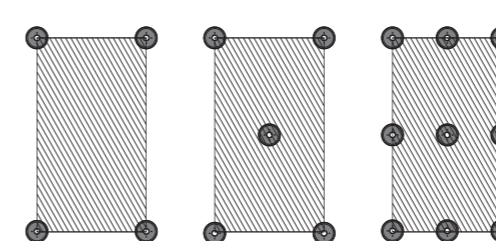

OUTDOOR PORCELAIN TILES

SPECIAL ELEMENTS

In order to guarantee excellent aesthetics and functionality for the various possible applications, the 20mm outdoor porcelain Our tile collections have a rich set of step elements and special pieces.

- ① Stair tile with straight edge
- ② Stair tile with rounded edge
- ③ Stair tile with straight ribbed edge
- ④ Stair tile with rounded ribbed edge
- ⑤ Right corner piece with straight edge
- ⑥ Right corner grid
- ⑦ Left corner grid

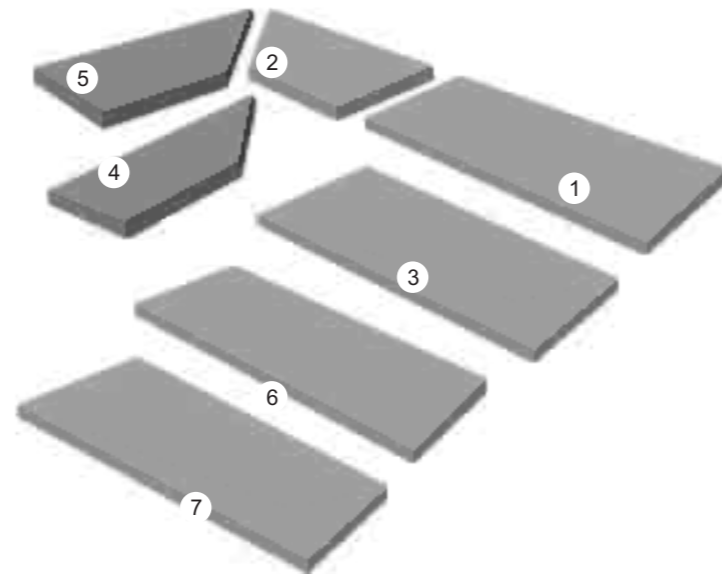

STAIR TILE WITH STRAIGHT EDGE

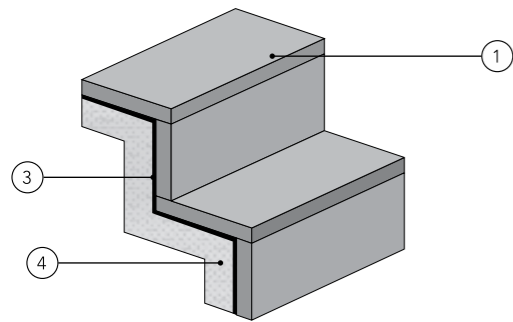

- ① Stair tile with straight edge
- ② Stair tile with rounded edge
- ③ Adhesiv
- ④ Screed
- ⑤ Flooring
- ⑥ Grid
- ⑦ Swimming pool covering

STAIR TILE WITH ROUNDED EDGE

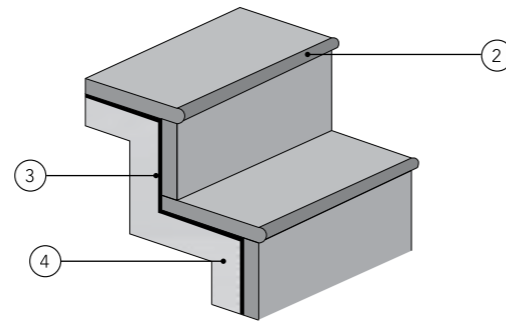

SWIMMING POOL EDGE

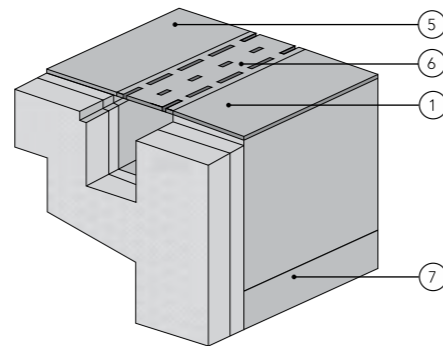

CAUTION

The images are to be taken as an indication, and have the sole purpose of showing how to obtain a correct flooring. It is recommended to always refer to the specific norms and regulations in each individual country and the instructions of the project supervisor.

TECHNICAL DETAILS

TEST DESCRIPTION	ISO-13006/EN176 GROUP BIA	MEAN VALUE OF OUR	TEST METHOD
Length & width	±0.6 %	±0.3mm	Passed
thickness	±5 %	±0.3mm	Passed
Straightness of side	±0.5 %	±0.3 %	Passed
Rectangularity	±0.6 %	±0.3 %	Passed
Surface flatness	±0.5 %	+0.35mm to -0.1mm	Passed
Surface quality	Minimum 95 %	Minimum 95 %	Passed
Water absorption	< 0.5 %	< 0.04 %	Passed
Breaking strength	> 1300N	> 1500N	Passed
Flexural strength (Average)	> 35N/mm ²	> 40N/mm ²	Passed
Scratch hardness of surface (Moh's scale)	> 6	> 6	Passed
Resistance to deep abrasion	<175mm ³	<144mm ³	Passed
Skid Resistance (Friction coefficient)	>0.4	>0.4	Passed
Bulk Density, in (g/cc)	>2	>2	Passed
Linear Thermal expansion	Max. 9.0 ⁻⁴ x K ⁻⁶ , Max	Max. 9.0 ⁻⁴ x K ⁻⁶ , Max	Passed
Thermal shock resistance	No damage	No damage	Passed
Frost resistance	Frost proof	Frost proof	Passed
Resistance to Chemical	Resistance	Resistance	Passed
Resistance to Stain	Resistant	Resistant	Passed
Moisture expansion	Nil	Nil	Passed
Colour resistance	Resistant	Resistant	Passed
Glossiness (Polished)	-	-	Passed

PACKING DETAILS (OUTDOOR):-

SIZE	BOX WEIGHT	PCS/BOX	SQM/BOX	SQFT/BOX	BOX/PALLET	PALLET/CTN	BOXES/CTN	TOTAL SQM/CTN	CTN WEIGHT (KG)
600x1200mm (20mm)	32.5	1	0.72	7.75	30	28	840	604.8	28000
600x900mm (20mm)	24.5	1	0.54	5.81	40	28	1120	604.8	28000
600X600 (20mm)	32	2	0.72	7.75	36	24	864	622.08	28000
600x1200mm (16mm)	25.5	1	0.72	7.75	70 & 34	12 & 7	1078	776.16	28000
600x900mm (16mm)	-	-	-	-	-	-	-	-	-
600X600mm (16mm)	25.5	2	0.72	7.75	40	27	1080	777.6	28000

The information contained in this catalogue is as accurate as possible, but cannot be considered as legally binding. The Company reserves the right to make any modification that becomes necessary due to production requirements. Weight colors and dimensions are subject to the inevitable variation typical of the ceramic firing process. The colors are possible to the actual colors, within the limits allowed by the printing process. For technical printing reasons, the colors shown may slightly differ from the actual tiles. VITRIFIED RESERVES THE RIGHT TO MODIFY THE TECHNICAL INFORMATION QUOTED IN THIS CATALOGUE.